

ETSI EN 302 208 V3.3.1 (2020-08)



**Radio Frequency Identification Equipment operating in the
band 865 MHz to 868 MHz with power levels up to 2 W and
in the band 915 MHz to 921 MHz with power levels up to 4 W;
Harmonised Standard for access to radio spectrum**

ReferenceREN/ERM-TG34-265

Keywordsharmonised standard, ID, radio, RFID, SRD

ETSI

650 Route des Lucioles
F-06921 Sophia Antipolis Cedex - FRANCE

Tel.: +33 4 92 94 42 00 Fax: +33 4 93 65 47 16

Siret N° 348 623 562 00017 - NAF 742 C
Association à but non lucratif enregistrée à la
Sous-Préfecture de Grasse (06) N° 7803/88

Important notice

The present document can be downloaded from:

<http://www.etsi.org/standards-search>

The present document may be made available in electronic versions and/or in print. The content of any electronic and/or print versions of the present document shall not be modified without the prior written authorization of ETSI. In case of any existing or perceived difference in contents between such versions and/or in print, the prevailing version of an ETSI deliverable is the one made publicly available in PDF format at www.etsi.org/deliver.

Users of the present document should be aware that the document may be subject to revision or change of status.

Information on the current status of this and other ETSI documents is available at

<https://portal.etsi.org/TB/ETSIDeliverableStatus.aspx>

If you find errors in the present document, please send your comment to one of the following services:

<https://portal.etsi.org/People/CommitteeSupportStaff.aspx>

Copyright Notification

No part may be reproduced or utilized in any form or by any means, electronic or mechanical, including photocopying and microfilm except as authorized by written permission of ETSI.

The content of the PDF version shall not be modified without the written authorization of ETSI.

The copyright and the foregoing restriction extend to reproduction in all media.

© ETSI 2020.

All rights reserved.

DECT™, **PLUGTESTS™**, **UMTS™** and the ETSI logo are trademarks of ETSI registered for the benefit of its Members.

3GPP™ and **LTE™** are trademarks of ETSI registered for the benefit of its Members and of the 3GPP Organizational Partners.

oneM2M™ logo is a trademark of ETSI registered for the benefit of its Members and of the oneM2M Partners.

GSM® and the GSM logo are trademarks registered and owned by the GSM Association.

Contents

Intellectual Property Rights	8
Foreword.....	8
Modal verbs terminology.....	8
1 Scope	9
2 References	9
2.1 Normative references	9
2.2 Informative references.....	10
3 Definition of terms, symbols and abbreviations.....	11
3.1 Terms.....	11
3.2 Symbols.....	12
3.3 Abbreviations	12
4 Technical requirements specifications	13
4.1 Environmental profile.....	13
4.2 General requirements	13
4.2.1 Conformance requirements.....	13
4.2.2 Designated frequencies	14
4.2.2.1 Lower band	14
4.2.2.2 Upper band.....	14
4.2.3 Testing of operational frequencies.....	15
4.2.4 General considerations.....	16
4.2.5 Interrogator Category.....	16
4.2.6 Choice of samples for test suite	16
4.3 Transmitter conformance requirements.....	16
4.3.1 Frequency error.....	16
4.3.1.1 Applicability.....	16
4.3.1.2 Definition	17
4.3.1.3 Limits	17
4.3.1.4 Conformance.....	17
4.3.2 Frequency stability under low voltage conditions	17
4.3.2.1 Applicability.....	17
4.3.2.2 Definition	17
4.3.2.3 Limits	17
4.3.2.4 Conformance.....	17
4.3.3 Effective radiated power.....	17
4.3.3.1 Applicability.....	17
4.3.3.2 Definition	17
4.3.3.3 Limits	18
4.3.3.3.1 Operation in the lower band (865 MHz to 868 MHz)	18
4.3.3.3.2 Operation in the upper band (915 MHz to 921 MHz)	18
4.3.3.4 Conformance.....	18
4.3.4 Transmitter antenna beam-width	18
4.3.4.1 Applicability.....	18
4.3.4.2 Definition	18
4.3.4.3 Limits	18
4.3.4.4 Conformance.....	18
4.3.5 Transmitter spectrum masks	18
4.3.5.1 Applicability.....	18
4.3.5.2 Definition	19
4.3.5.3 Limits	19
4.3.5.3.1 Limits for lower band (865 MHz to 868 MHz)	19
4.3.5.3.2 Limits for upper band (915 MHz to 921 MHz)	19
4.3.5.4 Conformance.....	20
4.3.6 Transmitter spurious emissions.....	20
4.3.6.1 Applicability.....	20

4.3.6.2	Definition	20
4.3.6.3	Limits	20
4.3.6.4	Conformance	21
4.3.7	Transmission times	21
4.3.7.1	Applicability	21
4.3.7.2	Definition	21
4.3.7.3	Limits	21
4.3.7.4	Conformance	21
4.4	Receiver conformance requirements	22
4.4.1	Adjacent channel selectivity	22
4.4.1.1	Applicability	22
4.4.1.2	Definition	22
4.4.1.3	Limits	22
4.4.1.4	Conformance	22
4.4.2	Blocking or desensitization	22
4.4.2.1	Applicability	22
4.4.2.2	Definition	22
4.4.2.3	Limits	22
4.4.2.4	Conformance	22
4.4.3	Spurious emissions	23
4.4.3.1	Applicability	23
4.4.3.2	Definition	23
4.4.3.3	Limits	23
4.4.3.4	Conformance	23
4.4.4	Receiver spurious response rejection	23
4.4.4.1	Applicability	23
4.4.4.2	Definition	23
4.4.4.3	Limits	23
4.4.4.4	Conformance	23
4.4.5	Receiver sensitivity	23
4.4.5.1	Applicability	23
4.4.5.2	Definition	23
4.4.5.3	Limits	24
4.4.5.4	Conformance	24
4.4.6	Receiver radio-frequency intermodulation	24
4.4.6.1	Applicability	24
4.4.6.2	Definition	24
4.4.6.3	Limits	24
4.4.6.4	Conformance	24
4.5	Tag conformance requirements	24
4.5.1	Radiated power (e.r.p.)	24
4.5.1.1	Applicability	24
4.5.1.2	Definition	24
4.5.1.3	Limits	25
4.5.1.4	Conformance	25
4.5.2	Unwanted emissions	25
4.5.2.1	Applicability	25
4.5.2.2	Definition	25
4.5.2.3	Limits	25
4.5.2.4	Conformance	26
5	Testing for compliance with technical requirements	27
5.1	Environmental conditions for testing	27
5.1.1	Normal and extreme test conditions	27
5.1.1.1	Normal test conditions	27
5.1.1.2	Extreme temperatures	27
5.1.1.2.1	Procedure for tests at extreme temperatures	27
5.1.1.2.2	Procedure for equipment designed for continuous operation	27
5.1.1.2.3	Procedure for equipment designed for intermittent operation	27
5.1.1.3	Extreme temperature ranges	28
5.1.2	Test power sources	28
5.1.2.1	General requirements	28

5.1.2.2	Normal test power source.....	28
5.1.2.2.1	Mains voltage	28
5.1.2.2.2	Regulated lead-acid battery power sources	28
5.1.2.2.3	Other power sources	29
5.1.2.3	Extreme test power source	29
5.1.2.3.1	Mains voltage	29
5.1.2.3.2	Regulated lead-acid battery power sources and gel-cell battery power sources	29
5.1.2.3.3	Power sources using other types of batteries	29
5.1.2.3.4	Other power sources	29
5.1.3	Testing under extreme conditions.....	29
5.2	Interpretation of the measurement results	29
5.3	Submission of equipment for testing.....	30
5.3.1	Mechanical and electrical design	30
5.3.1.1	General requirements	30
5.3.1.2	Controls	30
5.3.1.3	Transmitter shut-off facility	30
5.3.1.4	Battery saving circuit	30
5.3.1.5	Declarations by the manufacturer	30
5.3.1.6	Auxiliary test equipment	30
5.3.2	General conditions for testing of transmitters.....	30
5.3.2.1	Normal test signals and test modulation.....	30
5.3.2.2	Normal test signals for data.....	30
5.3.2.3	Artificial antenna.....	30
5.3.2.4	Modes of operation of the transmitter	31
5.3.2.5	Test sites and general arrangements for radiated measurements.....	31
5.3.2.6	Measuring receiver.....	31
5.3.2.7	Testing of operational frequencies	31
5.4	Presentation of equipment for testing.....	31
5.4.1	General requirements.....	31
5.4.2	Choice of model for testing	31
5.4.3	Provisions of samples for testing	32
5.4.4	Equipment without an internal permanent or temporary antenna connector	32
5.4.5	Test fixture.....	32
5.4.6	Submission of additional equipment with a temporary antenna connector.....	32
5.4.7	Void	33
5.4.8	Adjustable carrier levels	33
5.4.9	Test mode.....	33
5.5	Essential transmitter test suites.....	33
5.5.1	Measurement of frequency error for mains operated equipment	33
5.5.2	Frequency stability under low voltage conditions	33
5.5.3	Effective radiated power (e.r.p.)	34
5.5.3.1	General	34
5.5.3.2	Method of measurement.....	34
5.5.3.2.1	General	34
5.5.3.2.2	Radiated measurement.....	34
5.5.3.2.3	Conducted measurement.....	35
5.5.4	Transmitter antenna beam-width	36
5.5.4.1	General	36
5.5.4.2	Radiated measurement	36
5.5.5	Transmitter spectrum mask.....	37
5.5.5.1	Method of measurement.....	37
5.5.6	Transmitter spurious emissions.....	38
5.5.6.1	Method of measurement.....	38
5.5.6.2	Method of measuring the spurious power level in a specified load, clause 5.5.6.1 a) i).....	38
5.5.6.3	Method of measuring the spurious effective radiated power, clause 5.5.6.1 a) ii).....	39
5.5.6.4	Method of measuring spurious effective radiated power, clause 5.5.6.1 b).....	40
5.5.7	Transmission times	40
5.5.7.1	Method of measurement.....	40
5.5.8	Void	41
5.5.9	Channel use.....	41
5.5.9.1	Method of measurement.....	41
5.6	Essential receiver test suites	42

5.6.1	Adjacent channel selectivity	42
5.6.1.1	General	42
5.6.1.2	Method 1: Method of measuring radiated signals	42
5.6.1.3	Method 2: Conducted method of measurement.....	43
5.6.2	Blocking or desensitization.....	44
5.6.2.1	General	44
5.6.2.2	Method 1: Method of measuring radiated signals	44
5.6.2.3	Method 2: Conducted method of measurement.....	45
5.6.3	Receiver spurious response rejection.....	46
5.6.3.1	General	46
5.6.3.2	Method 1 of measuring radiated signals.....	46
5.6.3.3	Method 2: Conducted method of measurement.....	47
5.6.4	Receiver sensitivity.....	48
5.6.4.1	Method of measurement.....	48
5.6.5	Receiver radio-frequency intermodulation	49
5.6.5.1	General	49
5.6.5.2	Method 1: Method of measuring radiated signals	49
5.6.5.3	Method 2: Conducted method of measurement.....	51
5.7	Essential tag test suites	52
5.7.1	Tag radiated power (e.r.p.).....	52
5.7.1.1	Method of measurement.....	52
5.7.1.1.1	Measurement setup.....	52
5.7.1.2	Method of measuring the power in an un-modulated sub-carrier, clause 5.7.1.1 a).....	53
5.7.1.3	Method of measuring the power in a modulated sub-carrier, clause 5.7.1.1 b).....	54
5.7.2	Unwanted emissions	55
5.7.2.1	Method of measurement.....	55
Annex A (informative): Relationship between the present document and the essential requirements of Directive 2014/53/EU		58
Annex B (normative): Radiated measurement.....		60
B.1	Test sites and general arrangements for measurements involving the use of radiated fields	60
B.1.1	General	60
B.1.2	Anechoic chamber	60
B.1.3	Anechoic chamber with a conductive ground plane.....	61
B.1.4	Open Area Test Site (OATS)	62
B.1.5	Test antenna.....	63
B.1.6	Substitution antenna	63
B.1.7	Measuring antenna	64
B.1.8	Stripline arrangement	64
B.1.8.1	General.....	64
B.1.8.2	Description.....	64
B.1.8.3	Calibration	64
B.1.8.4	Mode of use	64
B.2	Guidance on the use of radiation test sites	64
B.2.1	General	64
B.2.2	Verification of the test site	65
B.2.3	Preparation of the EUT.....	65
B.2.4	Power supplies to the EUT	65
B.2.5	Range length.....	65
B.2.6	Site preparation	66
B.3	Coupling of signals.....	66
B.3.1	General	66
B.3.2	Data signals	66
B.4	Standard test position	67
B.5	Test fixture	67
B.5.1	General	67
B.5.2	Description	67
B.5.3	Calibration.....	68

B.5.4	Mode of use	69
Annex C (normative):	Void	70
Annex D (informative):	Measurement uncertainty	71
Annex E (informative):	Receiver parameter assessment.....	72
Annex F (informative):	Bibliography.....	73
Annex G (informative):	Change history	74
History		75

Intellectual Property Rights

Essential patents

IPRs essential or potentially essential to normative deliverables may have been declared to ETSI. The information pertaining to these essential IPRs, if any, is publicly available for **ETSI members and non-members**, and can be found in ETSI SR 000 314: "*Intellectual Property Rights (IPRs); Essential, or potentially Essential, IPRs notified to ETSI in respect of ETSI standards*", which is available from the ETSI Secretariat. Latest updates are available on the ETSI Web server (<https://ipr.etsi.org/>).

Pursuant to the ETSI IPR Policy, no investigation, including IPR searches, has been carried out by ETSI. No guarantee can be given as to the existence of other IPRs not referenced in ETSI SR 000 314 (or the updates on the ETSI Web server) which are, or may be, or may become, essential to the present document.

Trademarks

The present document may include trademarks and/or tradenames which are asserted and/or registered by their owners. ETSI claims no ownership of these except for any which are indicated as being the property of ETSI, and conveys no right to use or reproduce any trademark and/or tradename. Mention of those trademarks in the present document does not constitute an endorsement by ETSI of products, services or organizations associated with those trademarks.

Foreword

This Harmonised European Standard (EN) has been produced by ETSI Technical Committee Electromagnetic compatibility and Radio spectrum Matters (ERM).

The present document has been prepared under the Commission's standardisation request C(2015) 5376 final [i.10] to provide one voluntary means of conforming to the essential requirements of Directive 2014/53/EU on the harmonisation of the laws of the Member States relating to the making available on the market of radio equipment and repealing Directive 1999/5/EC [i.3].

Once the present document is cited in the Official Journal of the European Union under that Directive, compliance with the normative clauses of the present document given in table A.1 confers, within the limits of the scope of the present document, a presumption of conformity with the corresponding essential requirements of that Directive, and associated EFTA regulations.

The present document replaces all previous versions of ETSI EN 302 208.

National transposition dates	
Date of adoption of this EN:	4 August 2020
Date of latest announcement of this EN (doa):	30 November 2020
Date of latest publication of new National Standard or endorsement of this EN (dop/e):	31 May 2021
Date of withdrawal of any conflicting National Standard (dow):	31 May 2022

Modal verbs terminology

In the present document "**shall**", "**shall not**", "**should**", "**should not**", "**may**", "**need not**", "**will**", "**will not**", "**can**" and "**cannot**" are to be interpreted as described in clause 3.2 of the [ETSI Drafting Rules](#) (Verbal forms for the expression of provisions).

"**must**" and "**must not**" are **NOT** allowed in ETSI deliverables except when used in direct citation.

1 Scope

The present document specifies technical characteristics and methods of measurements for Radio Frequency Identification (RFID) devices used in the frequency ranges 865 MHz to 868 MHz and 915 MHz to 921 MHz.

Power limits up to a maximum of 2 W e.r.p. are specified for this equipment in the frequency band 865 MHz to 868 MHz and up to a maximum of 4 W e.r.p. in the frequency band 915 MHz to 921 MHz.

NOTE 1: The term frequency band is typically used for reference to dedicated bands as described in CEPT/ERC/REC 70-03 [i.9], while frequency range is used in the other cases.

The frequency usage conditions for RFID are EU wide harmonised in the band 865 MHz to 868 MHz according to [i.15] and in the band 915 MHz to 921 MHz according to [i.14]. According to [i.14] EU member states are requested to implement 3 channels only in the 915 MHz to 921 MHz band.

It should be noted that the frequency band 915 MHz to 921 MHz has only a limited implementation status within the European Union and the CEPT countries. CEPT/ERC/REC 70-03 [i.9] provides in appendix 1 an overview of countries where the band is implemented.

The present document applies to RFID interrogators and tags operating together as a system. For each specified band, multiple high power channels are made available for use by interrogators. The tags respond with a modulated signal preferably in the adjacent low power channels. Interrogators may be used with either integral or external antennas.

The types of equipment covered by the present document are as follows:

- fixed interrogators;
- portable interrogators;
- batteryless tags;
- battery assisted tags;
- battery powered tags.

These types of radio equipment are capable of operating in the frequency ranges given in table 1 and table 2.

The present document contains requirements to demonstrate that the specified radio equipment both effectively uses and supports the efficient use of radio spectrum in order to avoid harmful interference.

NOTE 2: The relationship between the present document and essential requirements of article 3.2 of Directive 2014/53/EU [i.3] is given in annex A.

2 References

2.1 Normative references

References are specific, identified by date of publication and/or edition number or version number. Only the cited version applies.

Referenced documents which are not found to be publicly available in the expected location might be found at <https://docbox.etsi.org/Reference/>.

NOTE: While any hyperlinks included in this clause were valid at the time of publication, ETSI cannot guarantee their long term validity.

The following referenced documents are necessary for the application of the present document.

- [1] Void.

- [2] IEEE/ANSI C63.5-2017: "American National Standard for Electromagnetic Compatibility-- Radiated Emission Measurements in Electromagnetic Interference (EMI) Control--Calibration and Qualification of Antennas (9 kHz to 40 GHz)".
- [3] Void.

2.2 Informative references

References are either specific (identified by date of publication and/or edition number or version number) or non-specific. For specific references, only the cited version applies. For non-specific references, the latest version of the referenced document (including any amendments) applies.

NOTE: While any hyperlinks included in this clause were valid at the time of publication, ETSI cannot guarantee their long term validity.

The following referenced documents are not necessary for the application of the present document but they assist the user with regard to a particular subject area.

- [i.1] Void.
- [i.2] Void.
- [i.3] Directive 2014/53/EU of the European Parliament and of the Council of 16 April 2014 on the harmonisation of the laws of the Member States relating to the making available on the market of radio equipment and repealing Directive 1999/5/EC.
- [i.4] IEC 60489-3 Appendix J Second edition (1988): "Methods of measurement for radio equipment used in the mobile services. Part 3: Receivers for A3E or F3E emissions" (pages 156 to 164).
- [i.5] Void.
- [i.6] Void.
- [i.7] Void.
- [i.8] Void.
- [i.9] CEPT/ERC/REC 70-03: "Short Range Devices (SRD)".
- [i.10] Commission implementing Decision C(2015) 5376 final of 4.8.2015 on a standardisation request to the European Committee for Electrotechnical Standardisation and to the European Telecommunications Standards Institute as regards radio equipment in support of Directive 2014/53/EU of the European Parliament and of the Council.
- [i.11] Void.
- [i.12] Void.
- [i.13] ETSI TR 102 273 (all parts) (V1.2.1) (12-2001): "Electromagnetic compatibility and Radio spectrum Matters (ERM); Improvement on Radiated Methods of Measurement (using test site) and evaluation of the corresponding measurement uncertainties".
- [i.14] Commission implementing Decision (EU) 2018/1538 of 11 October 2018 on the harmonisation of radio spectrum for use by short-range devices within the 874-876 and 915-921 MHz frequency bands.
- [i.15] Commission implementing Decision (EU) 2017/1483 of 8 August 2017 amending Decision 2006/771/EC on harmonisation of the radio spectrum for use by short-range devices and repealing Decision 2006/804/EC.
- [i.16] ERC Recommendation 74-01: "Unwanted emissions in the spurious domain", Approved 1998 amended 29 May 2019.
- [i.17] ISO/IEC 18046-2: "Information technology - Radio frequency identification device performance test methods - Part 2: Test methods for interrogator performance".

- [i.18] ISO/IEC 18046-3: Information technology - Radio frequency identification device performance test methods - Part 3: Test methods for tag performance".
- [i.19] ETSI EG 203 336: "Electromagnetic compatibility and Radio spectrum Matters (ERM); Guide for the selection of technical parameters for the production of Harmonised Standards covering article 3.1(b) and article 3.2 of Directive 2014/53/EU".
- [i.20] ISO/IEC 18000-63: "Information technology - Radio frequency identification for item management - Part 63: Parameters for air interface communications at 860 MHz to 960 MHz Type C".

3 Definition of terms, symbols and abbreviations

3.1 Terms

For the purposes of the present document, the following terms apply:

adaptive frequency agility: technique that allows an interrogator to change its frequency of operation automatically from one channel to another

battery assisted tag: transponder that includes a battery to enhance its receive performance and power its internal circuitry

batteryless tag: transponder that derives all of the power necessary for its operation from the field generated by an interrogator

battery powered tag: transponder that uses the power from its battery to perform all of its operational functions

conducted measurements: measurements which are made using a direct 50 Ω connection to the equipment under test

dedicated antenna: removable antenna supplied and type tested with the radio equipment, designed as an indispensable part of the equipment

dense interrogator mode: RFID operating mode in which multiple interrogators can transmit simultaneously in the same channel while tags respond in the adjacent channels

designated frequency band: frequency band within which the emission by a device is authorized

effective radiated power: product of the power supplied to the antenna and its gain relative to a half wave dipole in the direction of maximum gain

ER-GSM: extended band of 918 MHz to 921 MHz used by the railways

external antenna: antenna that may be connected to an interrogator via its external connector

Full Tests (FT): all tests specified in the present document

global scroll: test mode in which an interrogator is able to read the same tag continuously

integral antenna: permanent fixed antenna, which may be built-in, designed as an indispensable part of the equipment

interrogator: equipment that will activate an adjacent tag and read its data

NOTE: It may also enter or modify the information in a tag.

Limited Tests (LT): Tests that include:

- transmitter frequency error and frequency stability under low voltage conditions for mains operated equipment, see clause 4.3.1 of the present document;
- transmitter frequency stability under low voltage conditions, see clause 4.3.2 of the present document;
- transmitter effective radiated power, see clause 4.3.3 of the present document.

lower band: frequency range 865,0 MHz to 868,0 MHz designated for use by RFID

manufacturer: As given in article 2 of Directive 2014/53/EU [i.3].

radiated measurements: measurements which involve the absolute measurement of a radiated field

R-GSM: interoperable band of 921 MHz to 960 MHz used by the railways

tag: transponder that holds data and responds to an interrogation signal

talk mode: transmission of intentional radiation by an interrogator

upper band: frequency range 915,0 MHz to 921,0 MHz designated for use by RFID

3.2 Symbols

For the purposes of the present document, the following symbols apply:

C_L	Total cable loss in dB
dB	decibel
d	distance
f	frequency measured under normal test conditions
f_c	centre frequency of carrier transmitted by interrogator
f_e	the maximum frequency error as measured in clause 5.5.2
G_{IC}	Gain of a circular antenna in dBic
G_{MR}	Gain Measurement Receiver
Ω	Ohms
P_C	Power Carrier
P_{MR}	Signal strength received at the measurement receiver
λ	wavelength

3.3 Abbreviations

For the purposes of the present document, the following abbreviations apply:

AM	Amplitude Modulation
ANSI	American National Standards Institute
BER	Bit Error Ratio
BW	Bandwidth
CEPT	European Conference of Postal and Telecommunications administrations
e.r.p.	effective radiated power
EFTA	European Free Trade Association
EMC	ElectroMagnetic Compatibility
emf	electromotive force
ERC	European Radio communication Committee
ER-GSM	Extended Railways GSM
EUT	Equipment Under Test
FT	Full Tests
GSM	Global System for Mobile
LT	Limited Tests
OATS	Open Area Test Site
ppm	part per million
RBW	Resolution Bandwidth
RF	Radio Frequency
RFID	Radio Frequency Identification
R-GSM	Railway GSM
RMS	Root Mean Square
S_{ACH}	Selectivity Adjacent Channel
SBL	Signal Blocking Level
SRD	Short Range Device

TX	Transmitter
UHF	Ultra High Frequency
VSWR	Voltage Standing Wave Ratio

4 Technical requirements specifications

4.1 Environmental profile

The technical requirements of the present document apply under the environmental profile for operation of the equipment, which shall be declared by the manufacturer. The equipment shall comply with all the technical requirements of the present document which are identified as applicable in annex A at all times when operating within the boundary limits of the declared operational environmental profile.

4.2 General requirements

4.2.1 Conformance requirements

Interrogators shall transmit only in the high power channels specified in clause 4.2.2 for the purpose of communicating with tags at power levels up to the limits specified in clause 4.3.3.3.

When operating in the lower band, 865 MHz to 868 MHz, an interrogator may transmit a continuous signal on any of the high power channels for a period not exceeding the limit defined in clause 4.3.7.3. At the end of the transmission the interrogator shall not transmit again on the same channel for the period defined in figure 7 of clause 4.3.7.3.

Alternatively the interrogator may switch immediately to any one of the other high power channels and send a further continuous transmission in accordance with the requirements of clause 4.3.7.3. There is no limit to the number of times that this process may be repeated.

For the lower band interrogators shall support trigger techniques that indicate the presence or arrival of objects that may be tagged. Irrespective of the application, an interrogator operating in the lower band shall stop transmitting after it has ceased to read any further tags, as specified in clause 4.3.7.3.

For operation in the upper band, 915 MHz to 921 MHz, interrogators shall transmit on any of the high power channels but for no longer than is necessary to complete the intended operation.

NOTE 1: The frequency band 915 MHz to 921 MHz has only a limited implementation status within the European Union and the CEPT countries. CEPT/ERC/REC 70-03 [i.9] provides in appendix 1 an overview of countries where the band is implemented.

NOTE 2: According [i.14] EU member states are requested to implement 3 channels only in the 915 MHz to 921 MHz band.

In some CEPT countries the upper sub-band 918 MHz to 921 MHz or parts thereof is allocated to the railways for ER-GSM.

In some CEPT countries parts of the upper band are allocated for the exclusive use of the military and government services. This applies predominantly to the lower sub-band 915 MHz to 918 MHz.

Interrogators capable of operating in the band 915 MHz to 921 MHz shall provide a means to prevent operation at the restricted frequencies in the applicable member states.

Where an interrogator is only able to transmit on a single band, testing shall be performed in the applicable band.

In a preferred method of operation tags, which are activated by an interrogator transmitting in a high power channel, respond in the adjacent low power channels. This technique is called the dense interrogator mode. It has the benefit of separating the frequencies of transmission of the interrogators and tags, allowing multiple interrogators to share the same channel thereby improving system performance. It also minimizes the generation of inter-modulation products, which may disrupt the behaviour of tags.

Interrogators may also operate in a presence-sensing mode in which they periodically transmit to determine whether tags have entered their interrogation zones. When operating in this mode, interrogators shall restrict the length of each transmission to less than 1 s and the period between successive transmissions shall be no less than 100 ms. Once an interrogator has determined the presence of tags, it will commence its reading routine.

It is permissible for interrogators to transmit simultaneously in both the lower and upper bands.

4.2.2 Designated frequencies

4.2.2.1 Lower band

Interrogators operating in the lower band shall use any of the four specified high power channels illustrated in figure 1 and table 1. The centre frequency of the lowest channel shall be 865,7 MHz and the bandwidth of each high power channel shall be 200 kHz. The remaining three high power channels shall be spaced at equal intervals of 600 kHz. Tags should respond in the dense interrogator mode within the low power channels.

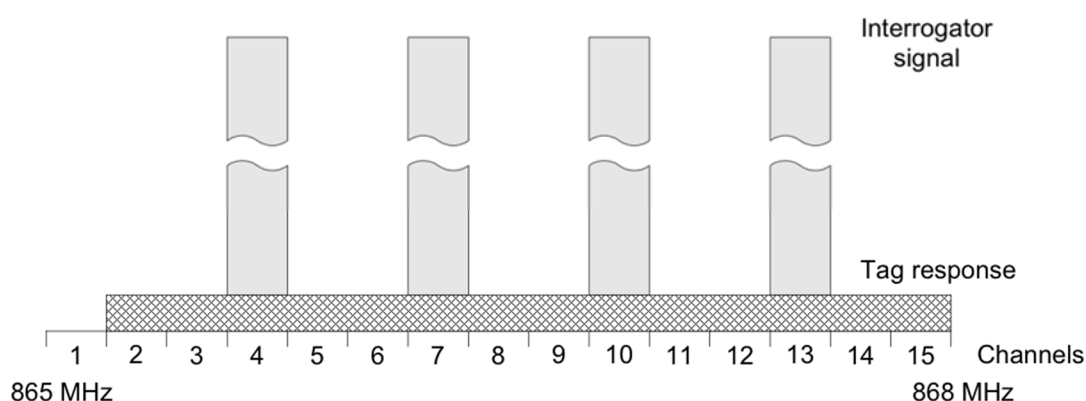

Figure 1: Channel plan for lower band

Table 1: Interrogator frequencies of operation in the lower band

Equipment	Operating frequencies
Interrogator Transmit channel 4	865,6 MHz to 865,8 MHz
Interrogator Transmit channel 7	866,2 MHz to 866,4 MHz
Interrogator Transmit channel 10	866,8 MHz to 867,0 MHz
Interrogator Transmit channel 13	867,4 MHz to 867,6 MHz

4.2.2.2 Upper band

For the upper band the centre frequency of the lowest channel shall be 916,3 MHz and the bandwidth of each high power channel shall be 400 kHz. The remaining high power channels shall be spaced at equal intervals of 1,2 MHz. Tags shall respond in the dense interrogator mode within the low power channels.

A diagram of the channel plan for the upper band is shown in figure 2 and table 1a, whereas it shall be noted that according to [i.14] EU member states are requested to implement only Interrogator Transmit channel 3 (916,1 MHz to 916,5 MHz), Interrogator Transmit channel 6 (917,3 MHz to 917,7 MHz) and Interrogator Transmit channel 9 (918,5 MHz to 918,9 MHz). Furthermore, some EU member states may even implement less channel or no channel at all for RFID. [i.14] notes 5, 6 and 7 contain more details. For example that some EU Member States may limit usage of this entry such that installation and operation are performed only by professional users and may consider individual authorisation, e.g. to administer geographical sharing and/or the application of mitigation techniques to ensure protection of radio services.

Interrogators shall have means that limit the channels to be used for operation, whereas such means shall be tested according to clause 5.5.8.

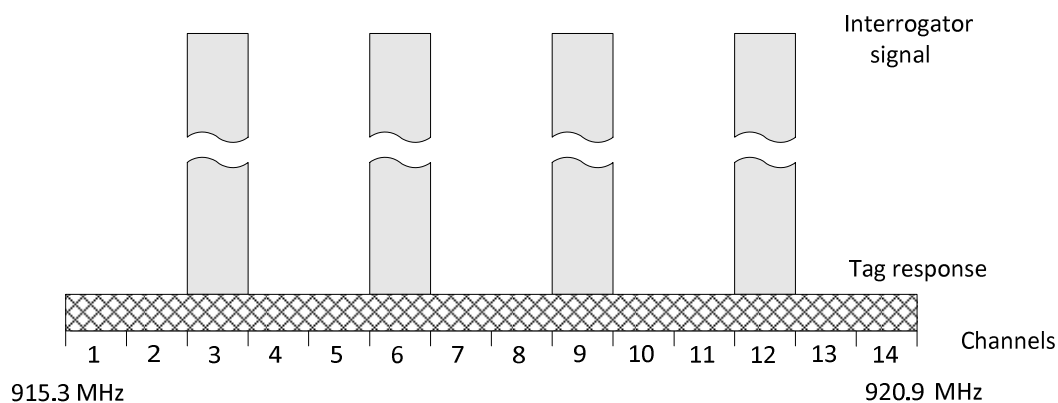

Figure 2: Channel plan for upper band

Table 1a: Interrogator frequencies of operation in the upper band

Equipment	Operating frequencies
Interrogator Transmit channel 3	916,1 MHz to 916,5 MHz
Interrogator Transmit channel 6	917,3 MHz to 917,7 MHz
Interrogator Transmit channel 9	918,5 MHz to 918,9 MHz
Interrogator Transmit channel 12	919,7 MHz to 920,1 MHz

4.2.3 Testing of operational frequencies

Figures 3 and 4 shows the centre frequencies of the four high power channels permitted for use by interrogators within the two bands designated for RFID. Full (FT) and Limited (LT) Tests, as defined in clause 3.1, shall be carried out in the applicable channels at the frequencies shown in figures 3 and 4, whereas if not all 4 channels are supported, then FT shall apply for the lowest and highest channel tested.

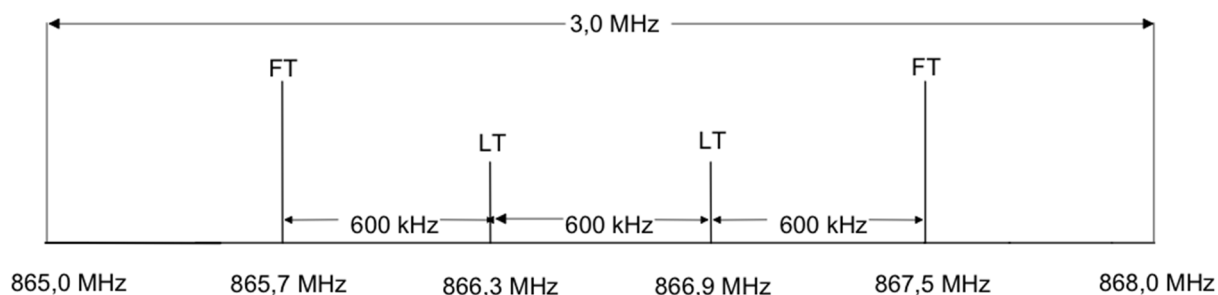

Legend: LT: Limited Tests, see clause 3.1.
FT: Full Tests, see clause 3.1.

Figure 3: Tests on a single sample for equipment in the lower band

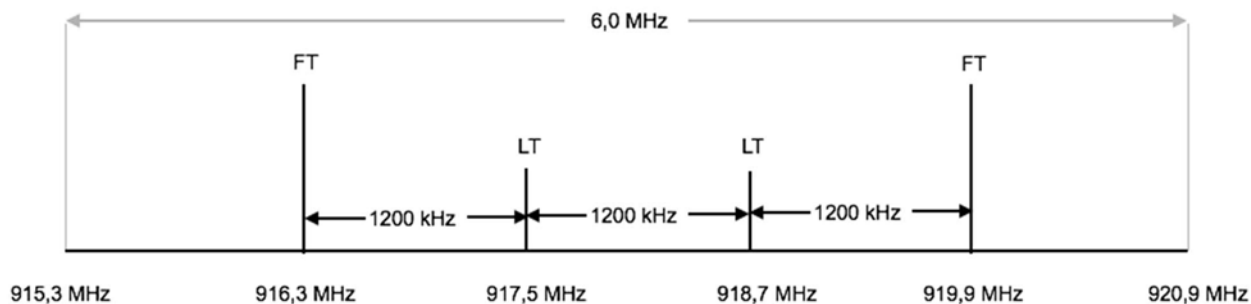

Figure 4: Tests on a single sample for equipment in the upper band

4.2.4 General considerations

The equipment tested shall be designed, constructed and manufactured in accordance with good engineering practice and with the aim of minimizing harmful interference to other equipment and services.

Each equipment submitted for testing, where applicable, shall fulfil the requirements of the present document on all frequencies over which it is intended to operate.

Where a manufacturer declares multiple operating frequencies, or highest and lowest operating frequencies and channel spacing, the difference between the values of two adjacent operating frequencies cannot be less than the value of the declared channel spacing.

4.2.5 Interrogator Category

RFID devices are used in a wide range of applications; therefore a range of interrogator categories is available with different levels of performance. The performance level chosen is related to the distance between the RFID interrogator and RFID tags or the RF propagation environment. The product family of RFID devices is therefore divided based on e.r.p, each having a set of relevant receiver requirements and minimum performance criteria.

An interrogator with an effective radiated power that does not exceed 30 dBm e.r.p shall be designated a Category II interrogator. An interrogator with an effective radiated power that does not exceed 13 dBm e.r.p. shall be designated a Category III interrogator. All other interrogators shall be designated as a Category I interrogator.

The receiver categories are listed in table 1b.

Table 1b: Interrogator categories

Interrogator category	Description
I	Category I is a high performance level of interrogator, typically used where the distance between the RFID interrogator and RFID tags is often greater than 10 m or in challenging RF propagation environments; e.g. large quantity of RFID tags in close proximity to each other or mounted on metals, liquids, etc. An example of an interrogator in this performance class is a fixed mounted interrogator situated at a dock door of a warehouse or manufacturing facility.
II	Category II is a performance level of interrogator, typically used for general purpose applications and where the distance between the RFID interrogator and RFID tags is typically lower than for category I. An example of an interrogator in this performance class is a handheld interrogator used in a retail store.
III	Category III is a performance level of interrogator, typically used for very short range application where the distance between the RFID interrogator and RFID tags is significantly lower than for category I or the RF integrator power is confined to a small area. An example of an interrogator in this performance class is an RFID tag printer or nearly contact reader.

4.2.6 Choice of samples for test suite

The manufacturer shall supply one or more samples of the equipment, as appropriate, for testing.

If an equipment has several optional features considered not to affect the RF parameters then tests need only be performed on the equipment configured with that combination of features considered to be the most complex. Equipment that does not have an external 50 Ω RF connector (integral antenna equipment), shall be presented for testing in accordance with clause 5.4.

4.3 Transmitter conformance requirements

4.3.1 Frequency error

4.3.1.1 Applicability

The requirement shall apply to interrogators able to transmit a modulated and un-modulated signal.

4.3.1.2 Definition

The frequency error is the difference between the frequency of the device under test measured under normal test conditions (see clause 5.1.1.1) and the frequency measured under extreme test conditions (see clause 5.1.1.2).

4.3.1.3 Limits

The maximum permitted frequency error, defined as the absolute value of $f_e - f$, shall not exceed ± 10 ppm relative to the nominal centre frequency of each of the applicable channels, where:

- f = the frequency measured under normal test conditions (see clause 5.1.1.1).
- f_e = the maximum frequency error as measured in clause 5.1.1.2.

NOTE: Where multiple interrogators are co-located, tighter limits may be necessary to avoid unacceptable beat tones.

4.3.1.4 Conformance

The conformance test suite for frequency error shall be as defined in clause 5.5.1 of the present document.

4.3.2 Frequency stability under low voltage conditions

4.3.2.1 Applicability

The frequency stability requirement shall apply to interrogators.

4.3.2.2 Definition

The frequency stability under low voltage conditions is the ability of the equipment to remain within its permitted frequency limits when the battery voltage falls below the lowest extreme voltage level.

4.3.2.3 Limits

The equipment shall either:

- transmit with a carrier frequency within the limits of ± 10 ppm whilst the radiated or conducted power is below the spurious emission limits; or
- automatically cease to function below the manufacturer's declared operating voltage.

NOTE: Where multiple interrogators are co-located, tighter limits may be necessary to avoid unacceptable beat tones.

4.3.2.4 Conformance

The conformance test suite for frequency stability shall be as defined in clause 5.5.2 of the present document.

4.3.3 Effective radiated power

4.3.3.1 Applicability

The effective radiated power requirement shall apply to all interrogators.

4.3.3.2 Definition

The effective radiated power is the product of the power supplied to the antenna and its gain relative to a half wave dipole in the direction of maximum gain.

4.3.3.3 Limits

4.3.3.3.1 Operation in the lower band (865 MHz to 868 MHz)

The effective radiated power on each of the four high power channels specified in clause 4.2.2.1 shall not exceed 33 dBm e.r.p. specified in a bandwidth of 200 kHz.

4.3.3.3.2 Operation in the upper band (915 MHz to 921 MHz)

The effective radiated power on each of the high power channels specified in clause 4.2.2.2 shall not exceed 36 dBm e.r.p. specified in a bandwidth of 400 kHz.

4.3.3.4 Conformance

The conformance test suite for the effective radiated power requirement shall be as defined in clause 5.5.3 of the present document.

4.3.4 Transmitter antenna beam-width

4.3.4.1 Applicability

The requirements for transmitter antenna beam-width shall apply to antennas connected to interrogators.

4.3.4.2 Definition

The beam-width of an antenna is the angle between the two half-power (-3 dB) points of the main lobe, when referenced to the peak effective radiated power of the main lobe.

4.3.4.3 Limits

The beam-width(s) of the antenna(s) in the horizontal orientation for the lower band shall comply with the following limits:

- For transmissions ≤ 500 mW e.r.p. there shall be no restriction on beam-width.
- For transmissions of > 500 mW e.r.p. to $\leq 1\,000$ mW e.r.p. beam-widths shall be $\leq 180^\circ$.
- For transmissions of $> 1\,000$ mW e.r.p. to $2\,000$ mW e.r.p. beam-widths shall be $\leq 90^\circ$.

The beam-width(s) of the antenna(s) in the horizontal orientation in the upper band shall comply with the following limits:

- For transmissions $\leq 1\,000$ mW e.r.p. there shall be no restriction on beam-width.
- For transmissions of $> 1\,000$ mW e.r.p. to $\leq 2\,000$ mW e.r.p. beam-widths shall be $\leq 180^\circ$.
- For transmissions of $> 2\,000$ mW e.r.p. to $4\,000$ mW e.r.p. beam-widths shall be $\leq 90^\circ$.

4.3.4.4 Conformance

The conformance test suite for the transmitter antenna beam-width shall be as defined in clause 5.5.4 of the present document.

4.3.5 Transmitter spectrum masks

4.3.5.1 Applicability

The requirement for transmitter spectrum masks shall apply to all interrogators.

4.3.5.2 Definition

A spectrum mask is a mathematically defined set of lines applied to the levels of radio transmissions.

4.3.5.3 Limits

4.3.5.3.1 Limits for lower band (865 MHz to 868 MHz)

For measurements performed in the lower band, the absolute levels of RF power at any frequency shall not exceed the limits defined by the envelope in the spectrum mask at figure 5 in which the Y axis is scaled in dBm e.r.p. and referenced to 1 kHz resolution bandwidth.

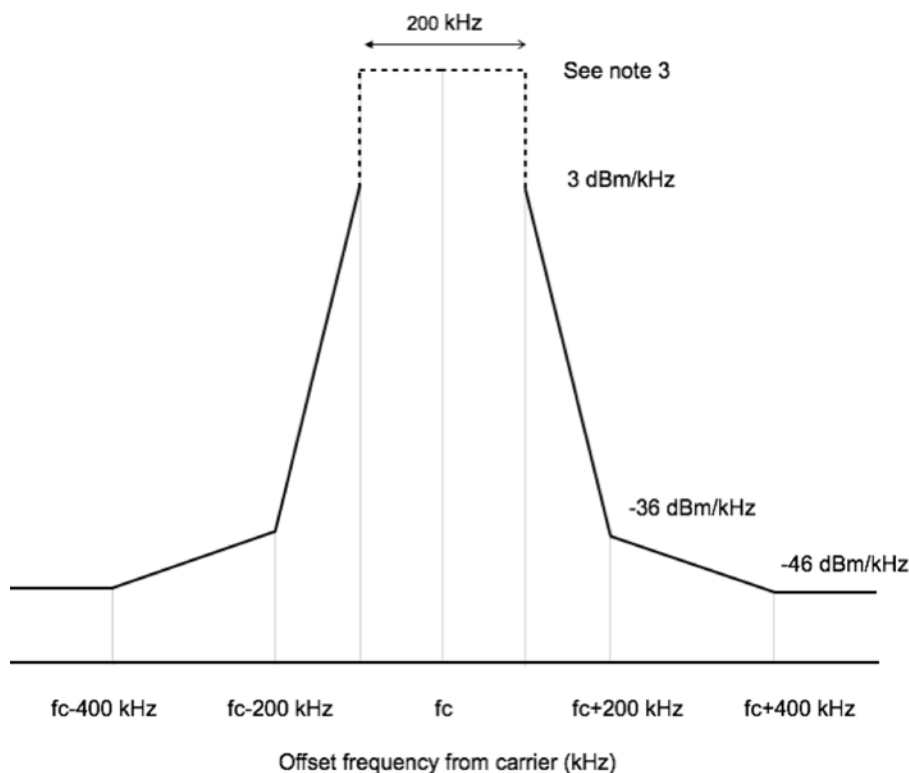

NOTE 1: Where f_c is the centre frequency of the carrier transmitted by the interrogator applicable over the frequency range $f_c \pm 500$ kHz.

NOTE 2: All limits are shown with reference to a resolution bandwidth of 1 kHz.

NOTE 3: Measurements in the frequency range $f_c \pm 100$ kHz shall be made in accordance with clauses 4.3.3 and 5.5.3.

NOTE 4: This figure considers the spurious emissions limits as of table 2.

Figure 5: Spectrum mask for modulated signals in the lower band

4.3.5.3.2 Limits for upper band (915 MHz to 921 MHz)

For measurements performed in the upper band the absolute levels of RF power at any frequency shall not exceed the limits defined by the envelope in the spectrum mask at figure 6 in which the Y axis is scaled in dBm e.r.p. and referenced to 1 kHz resolution bandwidth.

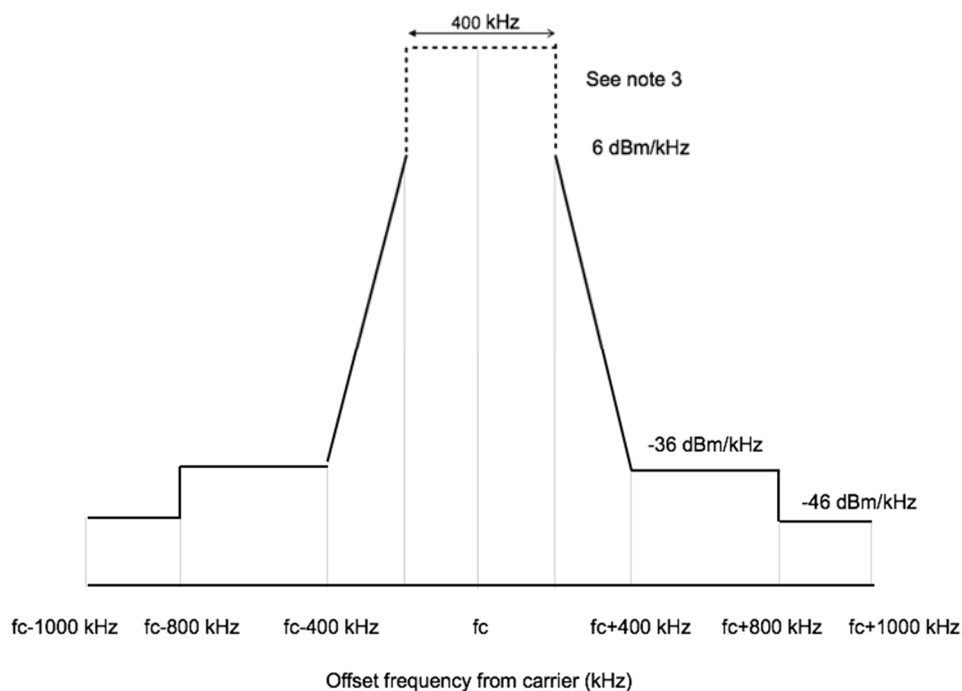

NOTE 1: Where f_c is the centre frequency of the carrier transmitted by the interrogator applicable over the frequency range $f_c \pm 1\,000$ kHz.

NOTE 2: All limits are shown with reference to a resolution bandwidth of 1 kHz.

NOTE 3: Measurements in the frequency range $f_c \pm 200$ kHz shall be made in accordance with clauses 4.3.3 and 5.5.3.

NOTE 4: This figure considers the spurious emissions limits as of table 2.

Figure 6: Spectrum mask for modulated signals in the upper band

4.3.5.4 Conformance

The conformance test suite for the transmitter spectrum masks shall be as defined in clause 5.5.5 of the present document.

4.3.6 Transmitter spurious emissions

4.3.6.1 Applicability

The requirements for transmitter spurious emissions shall apply to all interrogators.

4.3.6.2 Definition

A spurious emission is any signal produced by the interrogator that falls outside of the band on which the equipment is meant to operate.

4.3.6.3 Limits

The level of any spurious emission, conducted or radiated, outside the frequency ranges covered in clause 4.3.5.3 shall not exceed the values given in table 2.

Table 2: Spurious emission limits in e.r.p. (according to [i.16])

State	87,5 MHz to 118 MHz 174 MHz to 230 MHz 470 MHz to 692 MHz	Other frequencies below 1 000 MHz	Frequencies above 1 000 MHz
Operating	4 nW (-54 dBm)	250 nW (-36 dBm)	1 μ W (-30 dBm)
Standby	2 nW (-57 dBm)	2 nW (-57 dBm)	20 nW (-47 dBm)

NOTE: For frequencies below 1 000 MHz limits are specified for a RBW of 100 kHz. Above 1 000 MHz a RBW of 1 MHz applies.

4.3.6.4 Conformance

The conformance test suite for the spurious emission limits shall be as defined in clause 5.5.6 of the present document.

4.3.7 Transmission times

4.3.7.1 Applicability

The requirement for transmission times shall apply to all interrogators.

4.3.7.2 Definition

The transmission time is the period of continuous transmission generated by an interrogator.

NOTE: The maximum period of continuous transmission and the period between consecutive transmissions on the same channel are specified in order to ensure most efficient use of available channels for the general benefit of all users.

4.3.7.3 Limits

For interrogators designed to operate in the lower band, the measured length of transmission at step 3 of clause 5.5.7.1 shall be no greater than is required to read the tags present in the field and to verify that there are no additional tags present in accordance with the intended operation. The present document does not specify particular means on how to accommodate this. For example this may be realized by means of triggers for motion, light beam or by applying a duty cycles for polling.

In addition, for the lower band, the maximum length of continuous transmission and the interval between repeated transmissions measured at step 6 of clause 5.5.7.1 shall comply with the two limits in figure 7.

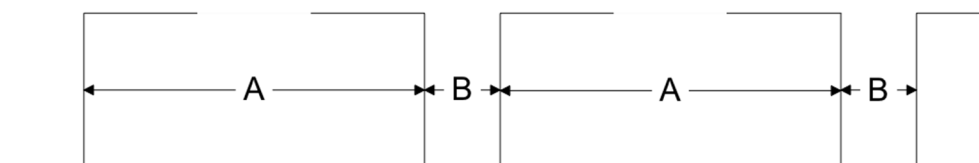

Figure 7: Repeated transmissions on the same channel

Where:

- 1) the on-duration of A shall not exceed 4 s;
- 2) the off-duration of B shall be not less than 100 ms.

When operating in the lower band, it is permitted for an interrogator to switch its transmission repeatedly between channels at intervals not exceeding 4 s. An interrogator shall not return to a previous channel within a period of less than 100 ms.

There is no specific limit to the length of transmission for interrogators when transmitting in the upper band.

4.3.7.4 Conformance

The conformance test suite for the transmission times shall be as defined in clause 5.5.7 of the present document.

4.4 Receiver conformance requirements

4.4.1 Adjacent channel selectivity

4.4.1.1 Applicability

This requirement applies to all interrogators.

4.4.1.2 Definition

The adjacent channel selectivity is a measure of the capability of the receiver in an interrogator to identify a tag while rejecting an unwanted signal from another device transmitting in one of the adjacent high power channels. The adjacent channel in the lower band shall be at a frequency of $\pm 0,6$ MHz from the centre frequency of the selected channel. For the upper band the adjacent channel shall be at a frequency of $\pm 1,2$ MHz from the centre frequency of the selected channel.

4.4.1.3 Limits

The adjacent channel selectivity measured at the receiver of the interrogator shall be equal to or better than -26 dBm.

4.4.1.4 Conformance

The conformance test suite for the adjacent channel selectivity shall be as defined in clause 5.6.1 of the present document.

4.4.2 Blocking or desensitization

4.4.2.1 Applicability

This requirement applies to all interrogators.

4.4.2.2 Definition

Blocking or desensitization is a measure of the capability of the receiver to identify a tag in the presence of an unwanted input signal at frequencies other than those of the spurious responses or in the adjacent channels under normal test conditions.

4.4.2.3 Limits

The blocking level measured at the receiver to the interrogator under the above specified conditions shall be equal to or better than the following limits:

For ($f_c \pm 2$ MHz) -23 dBm

For ($f_c \pm 5$ MHz) -14 dBm

For ($f_c \pm 10$ MHz) -8 dBm

4.4.2.4 Conformance

The conformance test suite for blocking or desensitization shall be as defined in clause 5.6.2 of the present document.

4.4.3 Spurious emissions

4.4.3.1 Applicability

This requirement applies to interrogators with a specific receive only mode of operation. In all other cases the receiver shall be tested together with the transmitter in its operating mode as specified in clause 4.3.6.

4.4.3.2 Definition

Spurious emissions from the receiver of an interrogator are emissions at any frequency when the equipment is not in the transmit mode.

4.4.3.3 Limits

The power of any spurious emission, radiated or conducted, shall not exceed the values given below:

- a) 2 nW e.r.p. below 1 000 MHz;
- b) 20 nW e.r.p. above 1 000 MHz.

4.4.3.4 Conformance

The conformance test suite for spurious emissions shall be as defined in clause 5.5.6 of the present document.

4.4.4 Receiver spurious response rejection

4.4.4.1 Applicability

This requirement applies to all interrogators.

4.4.4.2 Definition

The spurious response rejection is a measure of the capability of the receiver to receive a wanted signal without exceeding a given degradation due to the presence of an unwanted signal at any frequency at which a response is obtained. The frequencies of the adjacent signals (channels) are excluded.

4.4.4.3 Limits

The Receiver spurious response rejection shall be equal to or better than the following limits:

- For (fc /3) -34 dBm
- For (fc /2) -34 dBm

4.4.4.4 Conformance

The conformance test suite for spurious emissions shall be as defined in clause 5.6.3 of the present document.

4.4.5 Receiver sensitivity

4.4.5.1 Applicability

This requirement applies to all interrogators.

4.4.5.2 Definition

Receiver sensitivity is the ability to receive a wanted signal at low input signal levels while providing a pre-determined level of performance.

4.4.5.3 Limits

The Receiver sensitivity shall be equal to or better than the limits listed in table 2a, whereas the category is selected based on the e.r.p. as described in clause 4.2.5 and the limit in the table is for the interrogator receiver without antenna.

Table 2a: Receiver sensitivity limits

Category	Limit
Category I (> 30 dBm e.r.p.)	-60 dBm
Category II (> 13 to 30 dBm e.r.p.)	-55 dBm
Category III (\leq 13 dBm e.r.p.)	-45 dBm

4.4.5.4 Conformance

The conformance test suite for receiver sensitivity shall be as defined in clause 5.6.4 of the present document.

4.4.6 Receiver radio-frequency intermodulation

4.4.6.1 Applicability

This requirement applies to all interrogators.

4.4.6.2 Definition

The Receiver radio-frequency intermodulation response rejection is a measure of the capability of the receiver in an interrogator to identify a tag in the presence of at least two unwanted signals at frequencies f_1 and f_2 with a specific frequency relationship to the wanted signal frequency. In the lower band f_1 and f_2 shall be at a frequency of $f_c + 0,6$ MHz and $f_c + 1,2$ MHz from the centre frequency of the selected channel. For the upper band f_1 and f_2 shall be at a frequency of $f_c + 1,2$ MHz and $f_c + 2,4$ MHz from the centre frequency of the selected channel.

4.4.6.3 Limits

The adjacent channel selectivity measured at the receiver of the interrogator shall be equal to or better than -34 dBm.

4.4.6.4 Conformance

The conformance test suite for the intermodulation response rejection shall be as defined in clause 5.6.5 of the present document.

4.5 Tag conformance requirements

4.5.1 Radiated power (e.r.p.)

4.5.1.1 Applicability

This requirement applies to all RFID tags operating in the lower or upper band.

4.5.1.2 Definition

The effective radiated power of a tag is the power radiated by its antenna in its direction of maximum gain under specified conditions of measurement.

4.5.1.3 Limits

For the lower band the radiated power of the tag shall not exceed -20 dBm e.r.p. which is equivalent to a power spectrum density of -25 dBm/100 kHz e.r.p.

For the upper band the radiated power of the tag shall not exceed -10 dBm e.r.p. which is equivalent to a power spectrum density of -18 dBm/100 kHz e.r.p.

NOTE: The values for the radiated power of the tag is determined as follows:

For the lower band this is based on 320 kHz bandwidth for the Tag wanted emissions.

- This calculates: $-20 \text{ dBm}/320 \text{ kHz} = -25 \text{ dBm}/100 \text{ kHz}$
- Prove: $5 \text{ dB} = 10\log_{10}(k) \rightarrow k = 10^{(5/10)}$, $k \sim 3,2$

For the upper band this is based on 640 kHz bandwidth for the Tag wanted emissions. This calculates:

- This calculates: $-10 \text{ dBm}/640 \text{ kHz} = -18 \text{ dBm}/100 \text{ kHz}$
- Prove: $8 \text{ dB} = 10\log_{10}(k) \rightarrow k = 10^{(8/10)}$, $k \sim 6,4$

4.5.1.4 Conformance

The conformance test suite for the radiated power of a tag shall be as defined in clause 5.7.1 of the present document.

4.5.2 Unwanted emissions

4.5.2.1 Applicability

This requirement applies to all RFID tags operating at UHF.

4.5.2.2 Definition

The unwanted emissions from a tag include both the out-of-band and the spurious emissions from a continuously modulated tag measured outside its wanted carrier frequency and associated sidebands when the tag is orientated for optimum coupling at a defined distance from the antenna of an interrogator, which is transmitting a continuous un-modulated carrier at a specified power level.

4.5.2.3 Limits

For the lower band the unwanted emissions from the tag under the above specified conditions at any frequency outside the band $f_c - 400 \text{ kHz}$ to $f_c + 400 \text{ kHz}$ shall not exceed the levels defined in the spectrum mask in figure 8.

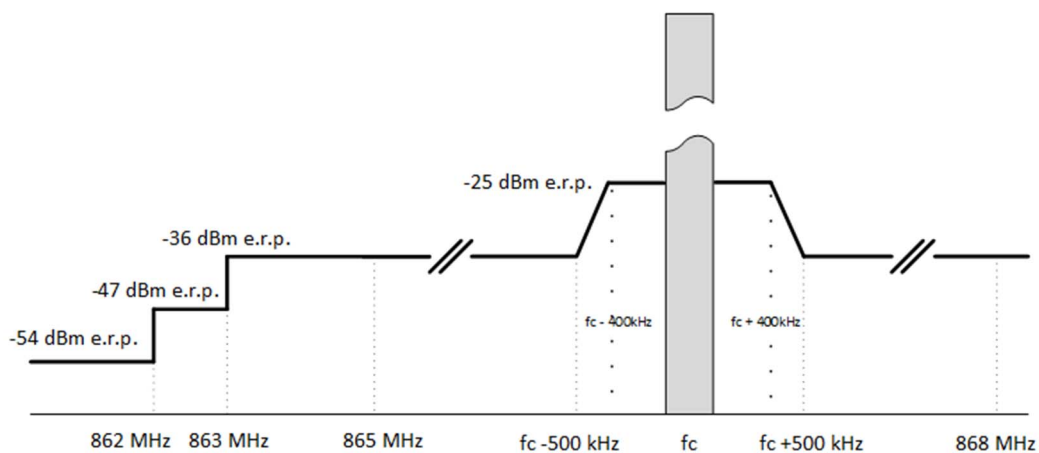

NOTE 1: f_c is the centre frequency of the carrier transmitted by the interrogator.

NOTE 2: The transmit channel occupied by the interrogator is shown in grey.

NOTE 3: All power levels in the unwanted domain relate to the resolution bandwidths in figure 10.

Figure 8: Spectrum mask for tag for the lower band

For the upper band the unwanted emissions from the tag under the above specified conditions at any frequency outside the band $f_c - 800$ kHz to $f_c + 800$ kHz shall not exceed the levels defined in the spectrum mask in figure 9.

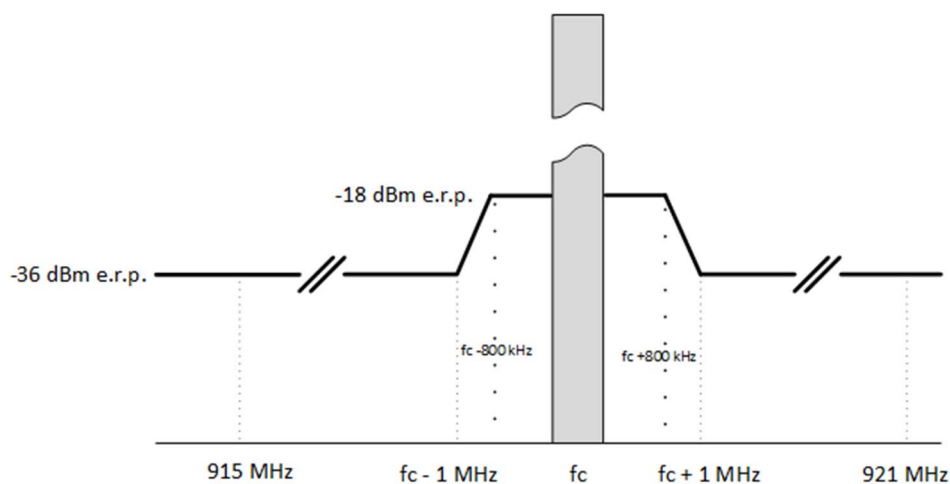

NOTE 1: f_c is the centre frequency of the carrier transmitted by the interrogator.

NOTE 2: The transmit channel occupied by the interrogator is shown in grey.

NOTE 3: All power levels in the unwanted domain relate to the resolution bandwidths in figure 11.

Figure 9: Spectrum mask for tag for the upper band

4.5.2.4 Conformance

The conformance test suite for the unwanted emissions from a tag shall be as defined in clause 5.7.2 of the present document.

5 Testing for compliance with technical requirements

5.1 Environmental conditions for testing

5.1.1 Normal and extreme test conditions

5.1.1.1 Normal test conditions

The normal temperature and humidity conditions for tests shall be any convenient combination of temperature and humidity within the following ranges:

- Temperature +15 °C to +35 °C;
- Relative humidity 20 % to 75 %.

When it is impracticable to carry out tests under these conditions, a note to this effect, stating the ambient temperature and relative humidity during the tests, shall be added to the test report.

5.1.1.2 Extreme temperatures

5.1.1.2.1 Procedure for tests at extreme temperatures

Before measurements are made the equipment shall have reached thermal balance in the test chamber. The equipment shall be switched off during the temperature stabilizing period.

In the case of equipment containing temperature stabilization circuits designed to operate continuously, the temperature stabilization circuits shall be switched on for 15 minutes after thermal balance has been obtained, and the equipment shall then meet the specified requirements.

If the thermal balance is not checked by measurements, a temperature stabilizing period of at least one hour shall be allowed. The sequence of measurements shall be chosen, and the humidity content in the test chamber shall be controlled so that excessive condensation does not occur.

5.1.1.2.2 Procedure for equipment designed for continuous operation

If the manufacturer states that the equipment is designed for continuous operation, the test procedure shall be as follows:

- Before tests at the upper extreme temperature the equipment shall be placed in the test chamber and left until thermal balance is attained. The equipment shall then be switched on in the transmit condition for a period of a half hour after which the equipment shall meet the specified requirements.
- For tests at the lower extreme temperature, the equipment shall be left in the test chamber until thermal balance is attained, then switched on for a period of one minute after which the equipment shall meet the specified requirements.

5.1.1.2.3 Procedure for equipment designed for intermittent operation

If the manufacturer states that the equipment is designed for intermittent operation, the test procedure shall be as follows:

- Before tests at the upper extreme temperature the equipment shall be placed in the test chamber and left until thermal balance is attained in the oven. The equipment shall then either:
 - transmit on and off according to the manufacturers declared duty cycle for a period of five minutes; or

- if the manufacturer's declared on period does not exceed one minute, then:
 - transmit in the on condition for a period not exceeding one minute, followed by a period in the off or standby mode for four minutes; after which the equipment shall meet the specified requirements.
- For tests at the lower extreme temperature, the equipment shall be left in the test chamber until thermal balance is attained, then switched to the standby or receive condition for one minute after which the equipment shall meet the specified requirements.

5.1.1.3 Extreme temperature ranges

For tests at extreme temperatures, measurements shall be made in accordance with the procedures specified in clause 5.1.1.2 at the upper and lower temperatures of one of the ranges specified in table 3.

Table 3: Extreme temperature ranges

Category	Temperature range
General	-20 °C to +55 °C
Portable equipment	-10 °C to +55 °C
Equipment for normal indoor use	5 °C to +35 °C

In order to comply with the present document, the device shall meet the requirements over the appropriate temperature range stated in table 3, or the environmental profile according to clause 4.1.

5.1.2 Test power sources

5.1.2.1 General requirements

During testing where possible the power source of the equipment shall be replaced by an external test power source capable of producing normal and extreme test voltages as specified in clauses 5.1.2.2 and 5.1.2.3.

The internal impedance of the external test power source shall be low enough for its effect on the test results to be negligible. For the purpose of the tests, the voltage of the external test power source shall be measured at the input terminals of the equipment. The external test power source shall be suitably de-coupled and applied as close to the equipment battery terminals as practicable. For radiated measurements, any external power leads shall be so arranged so as not to affect the measurements.

During tests, the test power source voltages shall be within a tolerance of $< \pm 1$ % relative to the voltage at the beginning of each test. The value of this tolerance can be critical for certain measurements. Using a smaller tolerance will provide a better uncertainty value for these measurements.

5.1.2.2 Normal test power source

5.1.2.2.1 Mains voltage

The normal test voltage for equipment to be connected to the mains shall be the nominal mains voltage. For the purpose of the present document, the nominal voltage shall be the declared voltage, or any of the declared voltages, for which the equipment was designed.

The frequency of the test power source corresponding to the ac mains shall be between 49 Hz and 51 Hz.

5.1.2.2.2 Regulated lead-acid battery power sources

When the radio equipment is intended for operation with the usual types of regulated lead-acid battery power source, the normal test voltage shall be 1,1 multiplied by the nominal voltage of the battery (6 V, 12 V, etc.).

5.1.2.2.3 Other power sources

For operation from other power sources or types of battery (primary or secondary), the normal test voltage shall be that declared by the equipment manufacturer and where appropriate agreed by the accredited test laboratory. Such values shall be stated.

5.1.2.3 Extreme test power source

5.1.2.3.1 Mains voltage

The extreme test voltages for equipment to be connected to an ac mains source shall be the nominal mains voltage $\pm 10\%$.

5.1.2.3.2 Regulated lead-acid battery power sources and gel-cell battery power sources

When the radio equipment is intended for operation with the usual type of regulated lead-acid battery power sources, the extreme test voltages shall be 1,3 and 0,9 multiplied by the nominal voltage of the battery (6 V, 12 V, etc.).

For float charge applications using "gel-cell" type batteries, the extreme test voltages shall be 1,15 and 0,85 multiplied by the nominal voltage of the declared battery voltage.

5.1.2.3.3 Power sources using other types of batteries

The lower extreme test voltages for equipment with power sources using batteries shall be as follows:

- for equipment with a battery indicator, the end point voltage as indicated;
- for equipment without a battery indicator, the following end point voltage shall be used:
 - for the Leclanché or the lithium type of battery:
 - 0,85 multiplied by the nominal voltage of the battery;
 - for the nickel-cadmium type of battery:
 - 0,9 multiplied by the nominal voltage of the battery;
- for other types of battery, the lower extreme test voltage for the discharged condition shall be declared by the equipment manufacturer.

The nominal voltage is considered to be the upper extreme test voltage in this case.

5.1.2.3.4 Other power sources

For equipment using other power sources, or capable of being operated from a variety of power sources, the extreme test voltages and sources used shall be recorded in the test report.

5.1.3 Testing under extreme conditions

Unless stated otherwise, tests performed under extreme test conditions shall apply the worst-case temperature and voltage conditions simultaneously.

5.2 Interpretation of the measurement results

The interpretation of the results recorded in the test report for the measurements described in the present document shall be as follows:

- the measured value related to the corresponding limit shall be used to decide whether an equipment meets the requirements of the present document.

Information on measurement uncertainty is available in annex D.

5.3 Submission of equipment for testing

5.3.1 Mechanical and electrical design

5.3.1.1 General requirements

The equipment submitted by the manufacturer shall be designed, constructed and manufactured in accordance with good engineering practice, and with the aim of minimizing harmful interference to other equipment and services.

Interrogators shall operate with the correct power source.

5.3.1.2 Controls

Those controls, which if maladjusted, may increase the interfering potential of the equipment, shall not be easily accessible to the user.

5.3.1.3 Transmitter shut-off facility

If the interrogator is equipped with an automatic transmitter shut-off facility, where appropriate, it should be made inoperative for the duration of the test.

5.3.1.4 Battery saving circuit

If the receiver is equipped with a battery-saving circuit, this circuit shall be made inoperative for the duration of the tests. In the case where this not possible, a proper test method shall be described and documented.

5.3.1.5 Declarations by the manufacturer

The manufacturer shall declare all necessary information concerning the equipment in respect of the technical requirements set out in the present document.

5.3.1.6 Auxiliary test equipment

All necessary test signal sources including sample tags and setting up information shall accompany the equipment when it is submitted for testing.

5.3.2 General conditions for testing of transmitters

5.3.2.1 Normal test signals and test modulation

The test-modulating signal is a signal that modulates a carrier and is dependent upon the type of equipment under test and also the measurement to be performed.

5.3.2.2 Normal test signals for data

Normal test signals shall represent the normal modulated carriers received both by the receiver of an interrogator and by a tag. They correspond to a single message triggered either manually or automatically. They are used for receiver methods of measurement where there is a need to transmit a single message repeatedly. This is achieved using a combined encoder and signal generator (for example a tag or interrogator) that shall be capable of supplying the test signal. Details of the test signal, including the data rate, modulation scheme and protocol, shall be supplied by the manufacturer and described in the test report.

5.3.2.3 Artificial antenna

Where applicable, tests shall be carried out using an artificial antenna, which shall be a substantially non-reactive non-radiating load of 50 Ω connected to the antenna connector. The Voltage Standing Wave Ratio (VSWR) at the 50 Ω connector shall not be greater than 1,2:1 over the frequency range of the measurement.

5.3.2.4 Modes of operation of the transmitter

For the purposes of the measurements according to the present document there should be a means to operate the transmitter in an un-modulated state. The manufacturer may also decide the method of achieving an un-modulated carrier, or special types of modulation patterns, the details of which shall be described in the test report (see clause 5.4.9). It may involve suitable temporary internal modifications of the equipment under test. If it is not possible to provide an un-modulated carrier then this shall be stated.

5.3.2.5 Test sites and general arrangements for radiated measurements

For guidance on radiation test sites, see annex B. Detailed descriptions of the radiated measurement arrangements are included in this annex.

5.3.2.6 Measuring receiver

The term measuring receiver refers to either a frequency selective voltmeter or a spectrum analyser. The reference bandwidth of the measuring receiver shall be as specified in the relevant clauses.

As technical performance varies according to environmental conditions, tests shall be carried out under a sufficient variety of environmental conditions as specified in the present document to give confidence of compliance for the affected technical requirements.

5.3.2.7 Testing of operational frequencies

Full (FT) and Limited (LT) Tests, as defined in clause 3.1, shall be carried out in the applicable channels at the frequencies shown in figures 3 and 4.

5.4 Presentation of equipment for testing

5.4.1 General requirements

Equipment submitted for testing shall fulfil the requirements of the present document on all frequencies over which it is intended to operate.

Manufacturers shall select frequencies of operation in accordance with the channel plans defined in clause 4.2.2 and in accordance with the power levels defined in clause 4.3.3.3.

If equipment is designed to operate with different carrier powers, measurement of each parameter of the transmitter shall be performed at the highest power level in each band at which the interrogator is intended to operate.

If a family of equipment has alternative output power levels provided by the use of separate power modules or add-on stages, then each module or add-on stage shall be tested in combination with the equipment. The necessary number of samples and additional tests shall be based on the requirements of clause 5.4.3.

To simplify and harmonise the testing procedures between the different testing laboratories, measurements shall be performed according to the present document on samples of equipment as defined in clause 5.4.3. These clauses are intended to give confidence that the requirements set out in the present document have been met without the necessity of performing the full measurements at all frequencies.

5.4.2 Choice of model for testing

The manufacturer shall supply one or more samples of the equipment, as appropriate, for testing.

If an equipment has several optional features considered not to affect the RF parameters then tests need only be performed on the equipment configured with that combination of features considered to be the most complex.

In the case of equipment without a 50 Ω external antenna connector, see clauses 5.4.4 to 5.4.6.

5.4.3 Provisions of samples for testing

Interrogators shall be submitted for test such that they may be configured to operate on each of the four high power channels within the relevant band(s) as specified in figures 3 and 4. It is only necessary for one sample of equipment to be tested.

The manufacturer shall supply a quantity of at least 3 pre-programmed tags with each interrogator that is submitted for test.

The manufacturer shall make available technical documentation and operating manuals, sufficient to allow testing to be performed. The test equipment used, together with relevant settings selected for the test, shall be recorded in the test report.

5.4.4 Equipment without an internal permanent or temporary antenna connector

The fact that use has been made of the internal antenna connection, or of a temporary connection, to facilitate measurements shall be recorded in the test report.

No connection shall be made to any internal permanent or temporary antenna connector during the performance of radiated emissions measurements, unless such action forms an essential part of the normal intended operation of the equipment as declared by the manufacturer.

5.4.5 Test fixture

With equipment intended for use with an integral antenna, and not equipped with a 50 Ω RF output connector, the manufacturer may supply a test fixture. This test fixture is a radio frequency coupling device for substituting the integral antenna with a 50 Ω radio frequency terminal at the working frequencies of the equipment under test. This allows certain measurements to be performed using conducted measurement methods. However, only relative measurements may be made. In addition, the test fixture shall provide, where applicable:

- 1) a connection to an external power supply;
- 2) a connection to a data interface.

The performance characteristics of the test fixture shall conform to the following basic parameters:

- 1) the circuitry associated with the RF coupling shall contain no active or non-linear devices;
- 2) the coupling loss shall not influence the measuring results;
- 3) the coupling loss shall be independent of the position of the test fixture and be unaffected by the proximity of surrounding objects or people;
- 4) the coupling loss shall be reproducible when the equipment under test is removed and replaced;
- 5) the coupling loss shall remain substantially constant when the environmental conditions are varied.

5.4.6 Submission of additional equipment with a temporary antenna connector

The manufacturer may submit one set of equipment with the normal antenna connected, to enable the radiated measurements to be made. The manufacturer shall attend the test laboratory at the conclusion of the radiated measurements, to disconnect the antenna and fit the temporary connector. The testing laboratory staff shall not connect or disconnect any temporary antenna connector.

Alternatively, the manufacturer may submit two sets of equipment to the test laboratory, one fitted with a temporary antenna connector with the antenna disconnected and the other with the antenna connected. Equipment shall be used for the appropriate tests. The manufacturer shall declare that the two sets of equipment are identical in all other respects.

5.4.7 Void

5.4.8 Adjustable carrier levels

Where the interrogator is designed with an adjustable carrier, then all transmitter parameters shall be measured using the highest power level. The equipment shall then be set to the lowest carrier power setting and the measurements for spurious emissions shall be repeated.

5.4.9 Test mode

The interrogator shall include a suitable test mode to permit testing of the parameters defined in clauses 5.5 and 5.6. The test mode shall be readily controlled by means, for example, of an external PC or terminal unit.

The test mode shall include the features listed below:

- 1) It shall be possible to set the interrogator to transmit a continuously un-modulated carrier on any one of the declared channels of operation.
- 2) While the interrogator is transmitting on a pre-selected channel, it shall be possible to read and log the identity of any valid tags that are present in the interrogation field.
- 3) It shall be possible to cause the interrogator to transmit normal test signals continuously as defined in clause 5.3.2.2 at its maximum data rate as declared by the manufacturer.
- 4) It shall be possible to configure a tag in a test mode such that, in the presence of an interrogation field, it transmits a continuous modulated response. Alternatively this requirement may be satisfied by a suitably configured test tag with an output that is representative of the production version.

The manufacturer shall describe the method of achieving the four test conditions, which shall be described in the test report.

5.5 Essential transmitter test suites

5.5.1 Measurement of frequency error for mains operated equipment

The measurements shall be made with the interrogator set to transmit a continuous un-modulated carrier and performed at each of the applicable frequencies specified in clause 4.2.3:

- a) Under normal test conditions:
 - The signal transmitted by the interrogator shall be connected by suitable means to the input of a frequency counter. The frequency displayed on the frequency counter shall be recorded.
- b) Under extreme test conditions:
 - For each combination of extreme voltage and temperature (see clause 5.1.3) the frequency displayed on the frequency counter shall be recorded. Four values shall be measured.

The results from the measurements shall be recorded in the test report.

5.5.2 Frequency stability under low voltage conditions

This test is for battery operated equipment.

- Step 1: An interrogator shall be set up to transmit a continuous un-modulated carrier. The signal transmitted by the interrogator shall be connected by suitable means to the input of a frequency counter.
- Step 2: The frequency displayed on the frequency counter shall be recorded.

- Step 3: The voltage from the test power source shall be reduced below the lower extreme test voltage limit towards zero. Whilst the voltage is reduced the carrier frequency shall be monitored.

The results from the measurements shall be recorded in the test report.

5.5.3 Effective radiated power (e.r.p.)

5.5.3.1 General

This measurement shall apply to equipment with an integral antenna and to equipment supplied with a dedicated external antenna. Both radiated and conducted methods of measurement are permitted. Where the conducted method is used the conducted power shall be adjusted to take into account the gain of the antenna and be stated as e.r.p.

If the equipment is designed to operate with different carrier powers in the lower and upper bands, the manufacturer shall declare the rated power for each of the bands, respectively.

5.5.3.2 Method of measurement

5.5.3.2.1 General

These measurements shall be performed with a continuous un-modulated carrier at the highest power level in each band at which the transmitter is intended to operate. Alternatively the interrogator shall be set to the highest power level in the intended band and transmit repeatedly in its normal operational mode.

If an RFID system includes active components between the interrogator and its antenna, the interrogator and the active components shall be subjected to extreme temperature tests.

The measurements shall be carried out under normal and extreme conditions as follows using clause 5.5.3.2.2 or clause 5.5.3.2.3 as appropriate:

- a) Under normal test conditions according to clause 5.1.1.1 and clause 5.1.2.2.
- b) Under extreme temperatures according to clauses 5.1.1.2 and 5.1.1.3, and extreme voltage and temperature according to clauses 5.1.2.3 and 5.1.3.

5.5.3.2.2 Radiated measurement

This measurement shall be carried out under normal test conditions only (see clause 5.1.1.1 and clause 5.1.2.2). The following steps shall be carried out in each of the bands specified in figures 1 and 2 in which the interrogator is designed to operate.

- Step 1: On a test site, selected from annex B, the interrogator antenna shall be placed at the specified height on a support, as specified in annex B, and in the position closest to normal use.
- Step 2: The interrogator shall be set to transmit continuously, with an unmodulated carrier, on one of the high power channels in the selected band. Alternatively if the interrogator is tested in its normal operational mode, it shall transmit repeatedly on the selected channel in accordance with the normal test signals for data specified in clause 5.3.2.2. The measuring receiver shall be positioned in the far field as defined in annex B and tuned to the frequency of the transmission under test.
- Step 3: A test antenna shall be oriented initially for vertical polarization and shall be chosen to correspond to the carrier frequency of the interrogator. The output of the test antenna shall be connected to a measuring receiver.

- Step 4: The measuring receiver shall be set to the following values:
- a) Resolution bandwidth: 300 kHz.
 - b) Video bandwidth: Equal to the RBW.
 - c) Sweep Time: Auto.
 - d) Span: 1 MHz for lower band and 2 MHz for upper band.
 - e) Trace mode: Max. hold sufficient to capture all emissions.
 - f) Detection mode: RMS.
- Step 5: The test antenna shall be raised and lowered through the specified heights until the maximum signal level is detected by the measuring receiver.
- Step 6: The interrogator shall then be rotated through 360° in the horizontal plane, until the maximum signal level is detected by the measuring receiver.
- Step 7: The test antenna shall be raised and lowered again through the specified heights until the maximum signal level is detected by the measuring receiver. The maximum signal level detected by the measuring receiver shall be noted.
- Step 8: The interrogator shall be replaced by a substitution antenna as defined in clause B.1.6. The substitution antenna shall be connected to a calibrated signal generator. The substitution antenna shall be orientated for vertical polarization and the length of the substitution antenna shall be adjusted to correspond to the frequency of transmission of the interrogator. If necessary, the setting of the input attenuator of the measuring receiver shall be adjusted in order to increase the sensitivity of the measuring receiver.
- Step 9: The test antenna shall be raised and lowered through the specified heights to ensure that the maximum signal is received.
- Step 10: The input signal to the substitution antenna shall be adjusted to give a level at the measuring receiver that is equal to the radiated power previously measured from the interrogator, corrected for any change to the setting of the input attenuator to the measuring receiver.
- Step 11: The input level to the substitution antenna shall be recorded as the power level, corrected for any change of input attenuator setting of the measuring receiver.
- Step 12: The measurement shall be repeated with the test antenna and the substitution antenna orientated for horizontal polarization.
- Step 13: The measure of the effective radiated power is the larger of the two levels recorded at the input to the substitution antenna, corrected if necessary for the gain of the substitution antenna.
- Step 14: With the interrogator antenna fitted into a suitable test fixture, the relative change of the effective radiated power between normal and extreme test conditions (see clauses 5.1.1.1 and 5.1.1.2 applied simultaneously) shall be compared. Any increase in the radiated power under extreme test conditions shall not cause the level to exceed the limits specified in clause 4.3.3. Instead of a suitable test fixture the equipment may also have a temporary internal 50 Ω connector installed for the purposes of testing.

5.5.3.2.3 Conducted measurement

Where an interrogator is fitted with an external antenna connector it is permissible to measure the conducted power. In this case the manufacturer shall declare the maximum gain and beam-width(s) of the external antenna(s) at the time that the equipment is presented for test. The following steps shall be carried out in each of the bands specified in figures 1 and 2 in which the interrogator is designed to operate.

- Step 1: The transmitter shall be configured to operate on one of the high power channels in the selected band and shall be connected to an artificial antenna (see clause 5.3.2.3). The carrier or mean power delivered to the artificial antenna shall be measured under normal test conditions (see clause 5.1.1.1).

Step 2: The measurement shall be repeated under extreme test conditions (see clauses 5.1.1.2 and 5.1.2.3 applied simultaneously).

Step 3: The recorded value shall be corrected for each of the antenna gains and be stated in e.r.p. To calculate the allowed conducted power with a circularly polarized antenna, formula (1) shall be used:

$$P_C = P_{erp} - G_{IC} + 5,15 + C_L \text{ dBm} \quad (1)$$

Where:

- P_C = interrogator conducted transmit power in dBm;
- G_{IC} = antenna gain of a circular antenna in dBic;
- C_L = total cable loss in dB.

Step 4: Where the interrogator switches between multiple transmitter outputs, the power level shall be measured at each output.

The results from the measurements shall be recorded in the test report.

5.5.4 Transmitter antenna beam-width

5.5.4.1 General

These measurements shall be performed with an un-modulated carrier at the highest power level in each band at which the transmitter is intended to operate. Alternatively the interrogator shall be set to the highest power level in the intended band and transmit repeatedly in its normal operational mode.

The measuring receiver shall be set up in accordance with the requirements of clause 5.3.2.6.

5.5.4.2 Radiated measurement

The following steps shall be carried out in each of the bands specified in figures 1 and 2 in which the interrogator is designed to operate.

- Step 1: On a test site, selected from annex B, the interrogator shall be placed at the specified height on a support, as specified in annex B, and in the position closest to normal use as declared by the manufacturer.
- Step 2: A test antenna shall be oriented initially for vertical polarization and shall be chosen to correspond to the carrier frequency of the interrogator. The output of the test antenna shall be connected to a measuring receiver.
- Step 3: The interrogator shall be set to transmit continuously, without modulation, on one of the high power channels in the selected band. The measuring receiver shall be positioned in the far field as defined in annex B and tuned to the frequency of the transmission under test.
- Step 4: The test antenna shall be raised and lowered through the specified heights until the maximum signal level is detected by the measuring receiver.
- Step 5: The interrogator shall then be rotated through 360° in the horizontal plane, until the maximum signal level is detected by the measuring receiver.
- Step 6: The test antenna shall be raised and lowered again through the specified heights until the maximum signal level is detected by the measuring receiver. The maximum signal level detected by the measuring receiver shall be noted.
- Step 7: The antenna of the interrogator shall be rotated in the horizontal plane in both directions to positions where the signal at the measuring receiver is reduced by 3 dB. The total angle of rotation (which is the horizontal beam-width of the antenna) shall be recorded.

5.5.5 Transmitter spectrum mask

5.5.5.1 Method of measurement

The following steps shall be carried out in each of the bands specified in figures 1 and 2 in which the interrogator is designed to operate.

The RF output of the equipment shall be connected to a spectrum analyser via a 50 Ω connector. In the case of equipment with an integral antenna, the equipment shall be placed in the test fixture (see clause 5.4.5) and the test fixture shall be connected to the spectrum analyser. Measurements shall be made on the declared channels of operation of the interrogator on those channels requiring full tests as defined in figures 3 and 4.

- Step 1: The interrogator shall be operated at the carrier power measured under normal test conditions in clause 5.1.1.1. The attenuator shall be adjusted to give an appropriate display on the spectrum analyser screen.
- Step 2: The interrogator shall be configured to generate a succession of modulated transmit pulses. Each transmit pulse shall be modulated by the normal test signal (see clause 5.3.2.2). The length of each transmit pulse shall be not less than 10 ms and not greater than 50 ms. The interval between successive transmit pulses shall be not less than 1 ms and shall not exceed 10 ms.
- Step 3: The output power of the interrogator, with or without a test fixture, shall be measured using a spectrum analyser, which shall be set to the following values:
- a) Resolution bandwidth: 1 kHz.
 - b) Video bandwidth: Equal to the RBW.
 - c) Sweep Time: Auto.
 - d) Span: 1 MHz.
 - e) Trace mode: Max. hold sufficient to capture all emissions.
 - f) Detection mode: Average.
- Step 4: For frequencies inside $f_c \pm 500$ kHz in the lower band and for frequencies inside $f_c \pm 1\,000$ kHz in the upper band, the measured values are the absolute values. The absolute levels of RF power shall be compared to the spectrum mask at figures 5 and 6 (see notes 1 and 2).
- Step 5: Where the interrogator includes multiple transmitter outputs, all of the outputs shall be connected via a suitable combiner network to the spectrum analyser. With the interrogator set up as in step 1 and configured to transmit the test signal described in step 2 while in its operational mode, the spectrum mask shall be measured at the spectrum analyser. The measured values shall be adjusted to compensate for the attenuation of the combiners and compared to the spectrum mask at figures 5 and 6.

NOTE: If for any reason the spectrum is measured with a resolution bandwidth other than 1 kHz, the measured values may be converted to the absolute values using formula (2):

$$B = A + 10 \log \frac{1\text{kHz}}{BW_{MEASURED}} \quad (2)$$

Where:

- A is the value at the measured resolution bandwidth;
- B is the absolute value referred to a 1 kHz reference bandwidth; or
- use the measured value, A, directly if the measured spectrum is a discrete spectral line (a discrete spectrum line is defined as a narrow peak with a level of at least 6 dB above the average level inside the measurement bandwidth).

5.5.6 Transmitter spurious emissions

5.5.6.1 Method of measurement

Spurious emissions shall be measured at frequencies outside $f_c \pm 500$ kHz for the lower band and frequencies outside $f_c \pm 1\,000$ kHz for the upper band, as specified in figures 10 and 11 below. The level of spurious emissions shall be measured as:

either:

- a) i) their power level in a specified load (conducted spurious emission); and
 - ii) their effective radiated power when radiated by the cabinet and structure of the equipment (cabinet radiation); or
- b) their effective radiated power when radiated by the cabinet and the integral antenna, in the case of equipment fitted with such an antenna and no external RF connector.

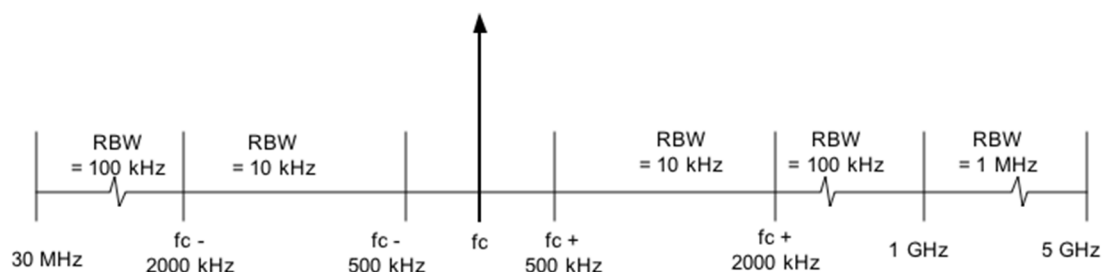

Figure 10: Resolution bandwidths for spurious emission in the lower band

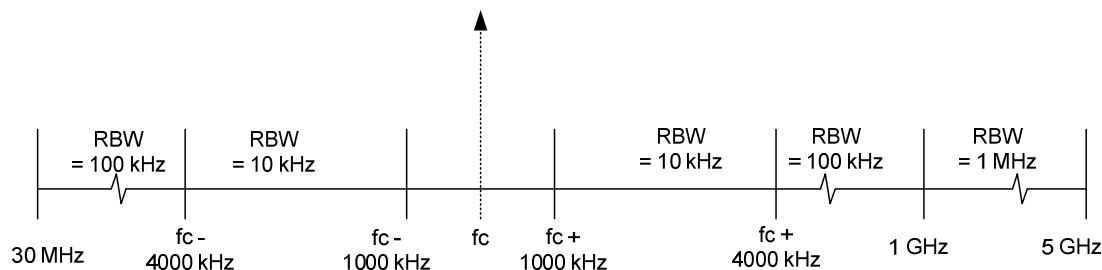

Figure 11: Resolution bandwidths for spurious emission in the upper band

The level of spurious emissions at any frequency shall not exceed the limits specified in table 2.

5.5.6.2 Method of measuring the spurious power level in a specified load, clause 5.5.6.1 a) i)

This method shall apply only to equipment with an external antenna connector.

- Step 1: The interrogator shall be connected to a $50\ \Omega$ power attenuator. The output of the power attenuator shall be connected to a measuring receiver. The interrogator shall be set up to generate a succession of modulated transmit pulses as described in step 2 of clause 5.5.5.1.

In the event that the carrier signal from the interrogator is too high for the dynamic range of the measurement receiver, a notch filter may optionally be connected between the $50\ \Omega$ power attenuator and the measurement receiver to attenuate the carrier signal. This may be used for measurements at greater than 2 MHz from the carrier. The filter shall have a loss of less than 3 dB at ± 1 MHz from f_c .

- Step 2: The measuring receiver, (see clause 5.3.2.6) shall be tuned over the frequency range of 30 MHz to 5 GHz. For each of the frequency ranges specified in figures 3 or 4 as applicable, the measuring receiver shall be set to the following values:
- a) Resolution bandwidth: In accordance with either figures 10 or 11 as applicable.
 - b) Video bandwidth: Equal to the RBW.
 - c) Sweep time: Auto.
 - d) Span: As defined by the relevant frequency ranges in either figures 10 or 11 as applicable.
 - e) Trace mode: Max. hold sufficient to capture emissions.
 - f) Detection mode: Average.
- Step 3: At each frequency at which a spurious component is detected, the power level shall be recorded as the conducted spurious emission level delivered into the specified load.
- Step 4: The measurements shall be repeated with the interrogator on stand-by.
- Step 5: The measurements shall be adjusted to give the output power of the interrogator with its declared antenna in e.r.p.

5.5.6.3 Method of measuring the spurious effective radiated power, clause 5.5.6.1 a) ii)

This method shall apply only to equipment with an external antenna connector.

- Step 1: On a test site, selected from annex B, the interrogator shall be placed at the specified height on a non-conducting support and in the position closest to normal use.
- Step 2: The antenna connector of the interrogator shall be connected to an artificial antenna (see clause 5.3.2.3).
- Step 3: A test antenna shall be orientated for vertical polarization and the length of the test antenna shall be chosen to correspond to the instantaneous frequency of the measuring receiver. The output of the test antenna shall be connected to a measuring receiver.
- In the event that the carrier signal from the interrogator is too high for the dynamic range of the measurement receiver, a notch filter may optionally be connected between the test antenna and the measurement receiver to attenuate the carrier signal. This may be used for measurements at greater than 2 MHz from the carrier. The filter shall have a loss of less than 3 dB at ± 1 MHz from f_c .
- Step 4: The interrogator shall be set up to generate a succession of modulated transmit pulses as described in step 2 of clause 5.5.5.1.
- Step 5: The measuring receiver (see clause 5.3.2.6) shall be tuned over the frequency range 30 MHz to 5 GHz, but excluding the frequencies inside $f_c \pm 500$ kHz for the lower band and for frequencies inside $f_c \pm 1\,000$ kHz for the upper band. The measurements shall be performed with the measuring receiver set to the following values:
- a) Resolution bandwidth: In accordance with either figures 10 or 11.
 - b) Video bandwidth: Equal to the RBW.
 - c) Sweep time: Auto.
 - d) Span: As defined by the relevant frequency ranges in either figures 10 or 11 as applicable.
 - e) Trace mode: Max. hold sufficient to capture emissions.
 - f) Detection mode: Average.

- Step 6: At each frequency at which a spurious component is detected, the test antenna shall be raised and lowered through the specified heights until a maximum signal level is detected by the measuring receiver.
- Step 7: The interrogator shall then be rotated through 360° in the horizontal plane, until the maximum signal level is detected by the measuring receiver and the test antenna height shall be adjusted again for maximum signal level.
- Step 8: The maximum signal level detected by the measuring receiver shall be noted.
- Step 9: The interrogator shall be replaced by a substitution antenna as defined in clauses B.1.4 and B.1.5.
- Step 10: The substitution antenna shall be orientated for vertical polarization and calibrated for the frequency of the spurious component detected.
- Step 11: The substitution antenna shall be connected to a calibrated signal generator.
- Step 12: The frequency of the calibrated signal generator shall be set in turn to the frequency of each of the spurious components detected. If necessary the input attenuator setting of the measuring receiver shall be adjusted in order to increase the sensitivity of the measuring receiver.
- Step 13: The test antenna shall be raised and lowered through the specified range of heights to ensure that the maximum signal is received. (When a test site according to clause B.1.2 is used, the height of the antenna need not be varied).
- Step 14: The input signal to the substitution antenna shall be adjusted to give a level at the measuring receiver, that is equal to the level noted while the spurious component was measured, corrected for any change to the setting of the input attenuator of the measuring receiver.
- Step 15: The input level to the substitution antenna shall be recorded as a power level, corrected for any change of input attenuator setting of the measuring receiver.
- Step 16: The measurement shall be repeated with the test antenna and the substitution antenna orientated for horizontal polarization.
- Step 17: The measure of the effective radiated power of the spurious components is the larger of the two power levels recorded for each spurious component at the input to the substitution antenna, corrected if necessary for the gain of the substitution antenna.
- Step 18: If applicable, the measurements shall be repeated with the interrogator on standby.

5.5.6.4 Method of measuring spurious effective radiated power, clause 5.5.6.1 b)

This method shall apply only to equipment without an external antenna connector. The method of measurement shall be performed according to clause 5.5.6.3, except that the interrogator output shall be connected to the integral antenna and not to an artificial antenna.

5.5.7 Transmission times

5.5.7.1 Method of measurement

This test shall apply to interrogators intended for operation in the lower band and is designed to verify that the interrogator shall transmit no longer than is necessary to perform the intended operation.

- Step 1: On a test site, selected from annex B, the equipment shall be placed at the specified height on a non-conducting support and in the position closest to normal use as declared by the manufacturer. The interrogator shall be configured to operate on one of the high power channels shown in figure 1. A small quantity of tags (typically up to 3) shall be positioned within the interrogation field of the interrogator.
- Step 2: A probe shall be positioned close to the antenna of the interrogator and arranged such that it will trigger a digital storage oscilloscope.

- Step 3: The interrogator shall initiate an interrogation sequence and the trace generated by the transmission shall be recorded on the digital storage scope. The length of the transmission shall be measured.
- Step 4: The interrogator shall then be configured to demonstrate reading an unlimited number of tags in the interrogation field. This may be achieved either by setting the interrogator to its "global scroll" mode with a single tag in the field or by replacing the tags with a test fixture that simulates an infinite number of tags.
- Step 5: The transmission from the interrogator shall be monitored on a digital storage oscilloscope using a probe positioned close to the antenna of the interrogator.
- Step 6: The maximum length of continuous transmission and the interval between repeated transmissions recorded on the digital storage oscilloscope shall comply with the permitted limits as stated in clause 4.3.7.3 and figure 7.

5.5.8 Void

Figure 12: Void

Figure 13: Void

5.5.9 Channel use

5.5.9.1 Method of measurement

The following steps shall be carried out in each of the transmit channels specified for the upper band in which the interrogator is designed to operate.

The RF output of the equipment shall be connected to a suitable antenna intended to be used in the application. In the case of equipment with an integral antenna the integral antenna shall be used. The equipment shall be placed in the test fixture (see clause 5.4.5) and the test fixture shall be connected to the spectrum analyser.

- Step 1: The interrogator shall be setup to operate utilizing a defined set of the supported channels according to figure 2 from clause 4.2.2.2 and under normal test conditions as in clause 5.1.1.1.
- Step 2: The interrogator shall be configured for normal operation with RFID tags, generating a succession of modulated transmit pulses, and showing that it continuously reads RFID tags.
- Step 3: A spectrum analyser shall be setup to capture the band from 860 MHz to 930 MHz for a duration of 10 minutes, whereas the arrangement of the spectrum analyser sense antenna, the interrogator antenna and the tags shall be placed in a way that interrogator signals can be clearly distinguished from tag signals.
- a) Resolution bandwidth: 10 kHz.
 - b) Video bandwidth: Equal to the RBW.
 - c) Sweep Time: Auto.
 - d) Span: 860 MHz to 930 MHz.
 - e) Trace mode: Max. hold sufficient to capture all emissions.
 - f) Detection mode: Average.
- Step 4: The test passes, if the interrogator only uses the channels of the defined set intended for the operation.
- Step 5: For other sets of supported channels, Steps 1 to 4 shall be repeated as applicable.

5.6 Essential receiver test suites

5.6.1 Adjacent channel selectivity

5.6.1.1 General

This measurement is required to ensure satisfactory operation of equipment in accordance with the band plan. Two alternative methods are specified:

- Method 1: without antenna connector
- Method 2: with antenna connector

5.6.1.2 Method 1: Method of measuring radiated signals

- Step 1: An interrogator shall be set up to operate at its maximum output power on a known channel (channels are defined in clause 4.2.2) either in an anechoic chamber or on an open air test site as specified in annex B. Furthermore, the interrogator shall be set up to operate in either the lower band to use a tag offset frequency to approximately 300 kHz, or in the upper band to use a tag offset of approximately 600 kHz. The interrogator shall be connected to an antenna with combined Tx and Rx functionality.
- Step 2: A tag with a sensitivity of better than -15 dBm shall be selected. With the tag in its preferred orientation it shall be moved slowly towards the interrogator in the direction of maximum gain of its antenna to a point where the tag is just identified. The distance d between the antenna of the interrogator and the tag shall be measured. If the distance between the tag and the interrogator is too great to fit within the anechoic chamber, an attenuator may be inserted between the interrogator and its antenna.
- Step 3: The tag shall then be moved to a new position that is at a distance of $0,7 d$ from the interrogator in the direction of maximum gain of its antenna.
- Step 4: A signal generator fitted with a directive antenna (e.g. horn antenna) shall be set up in accordance with figure 14 and its transmission directed at the antenna of the interrogator.

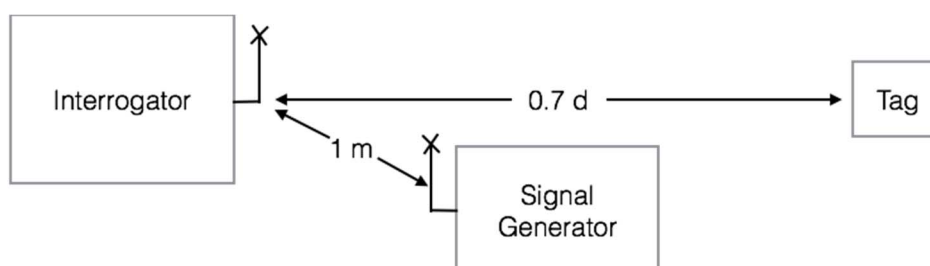

Figure 14: Radiated test set up for adjacent channel selectivity

- Step 5: The signal generator shall be adjusted to radiate a signal at a test frequency that lies at the mid-point of the upper adjacent channel (channels are defined in clause 4.2.2). The signal shall be an AM modulated sine wave to a depth of 80 % at a frequency of 40 kHz.
- Step 6: The level of the signal generator shall be increased until the interrogator just ceases to identify the tag with approximately 50 % success rate. The level of the signal generator shall then be reduced in 1 dB steps until the interrogator just identifies the tag again.
- Step 7: The interrogator shall be removed and replaced by a measurement antenna connected to a measurement receiver set to a resolution bandwidth of 100 kHz. The level of signal from the signal generator received at the measurement receiver shall be recorded.
- Step 8: The measurement shall be repeated for the lower adjacent channel.

Step 9: The absolute levels of the signals received by the measurement receiver from the signal generator shall be corrected using formula (3).

$$S_{ACH} = P_{MR} - G_{MR} \quad (3)$$

Where:

S_{ACH} is the adjacent channel selectivity in dBm.

P_{MR} is the signal strength received at the measurement receiver.

G_{MR} is the antenna gain of the measurement receiver antenna in dBi.

The corrected power level for each measurement shall be not less than the limit specified in clause 4.4.1.3.

Step 10: If the interrogator supports multiple bands then steps 1 to 9 shall be repeated respectively.

5.6.1.3 Method 2: Conducted method of measurement

Where the interrogator is fitted with an external antenna connector, the measurement may be made using a modified tag that provides a hard-wire connection.

Step 1: An interrogator shall be set up to operate at its maximum output power on a known channel (channels are defined in clause 4.2.2) in accordance with figure 15 below. Furthermore, the interrogator shall be set up to operate in either the lower band to use a tag offset frequency to approximately 300 kHz, or in the upper band to use a tag offset of approximately 600 kHz.

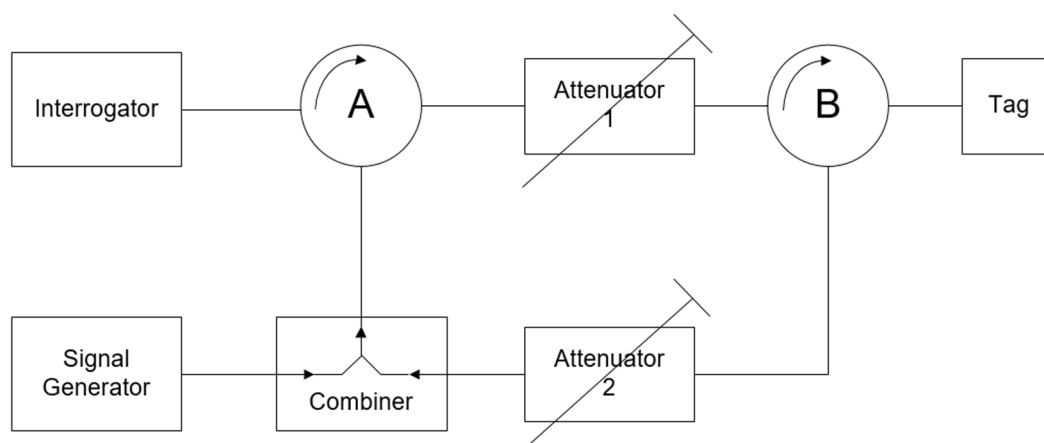

Figure 15: Conducted test set up for adjacent channel selectivity

- Step 2: To check that the tag is not activated by the interrogator via attenuator 2, attenuator 1 shall be removed from the circuit. The open port of circulators A and B shall each be terminated by a 50 Ω load resistor. With the signal generator switched off, the interrogator shall be switched on at its maximum output power on a known channel in the lower band. Attenuator 2 shall be increased until the interrogator just ceases to identify the tag with approximately 50 % success rate. The value of attenuator 2 shall be noted. For the remainder of the test attenuator 2 shall not be reduced below this value.
- Step 3: The 50 Ω load resistors shall be removed from circulators A and B and replaced by attenuator 1. With the signal generator switched off, the interrogator shall be switched on again at its maximum output power. Attenuator 1 shall be increased until it is just possible for the interrogator to read the tag. The setting of the attenuator 1 shall then be reduced by 10 dB to ensure that the tag remains fully activated.
- Step 4: With the signal generator switched off, attenuator 2 shall be increased until the interrogator is just able to identify the tag with approximately 50 % success rate. Attenuator 2 shall then be reduced by 3 dB to ensure that the interrogator receives an acceptable signal level from the tag.

- Step 5: The signal generator shall be adjusted to generate a signal at a test frequency that lies at the mid-point of the upper adjacent channel (channels are defined in clause 4.2.2). The signal shall be an AM sine wave modulated to a depth of 80 % at a frequency of 40 kHz.
- Step 6: The level of the signal generator shall be increased until the interrogator just ceases to identify the tag with approximately 50 % success rate. The level of the signal generator shall then be reduced in 1 dB steps until the interrogator just identifies the tag again. The level of signal from the signal generator shall be recorded.
- Step 7: The level of signal from the signal generator shall be adjusted to compensate for the losses in both circulator A and the power splitter to give the corrected signal received in dBm at the input of the interrogator.
- Step 8: The measurement shall be repeated for the lower adjacent channel.
- Step 9: The absolute level of the signals from the signal generator referred to the input of the interrogator in dBm shall be not less than the limit specified in clause 4.4.1.3.
- Step 10: If the interrogator supports multiple bands then steps 1 to 9 shall be repeated respectively.

The results shall be recorded in the test report.

5.6.2 Blocking or desensitization

5.6.2.1 General

This measurement is required to ensure satisfactory operation of equipment in accordance with the band plan. Two alternative methods are specified:

- Method 1: without antenna connector
- Method 2: with antenna connector

5.6.2.2 Method 1: Method of measuring radiated signals

- Step 1: An interrogator shall be set up to operate at its maximum output power on a known channel (channels are defined in clause 4.2.2) either in an anechoic chamber or on an open air test site as specified in annex B. Furthermore, the interrogator shall be set up to operate in either the lower band to use a tag offset frequency to approximately 300 kHz, or in the upper band to use a tag offset of approximately 600 kHz. The interrogator shall be connected to an antenna with combined Tx and Rx functionality.
- Step 2: A tag with a sensitivity of better than -15 dBm shall be selected. With the tag in its preferred orientation it shall be moved slowly towards the interrogator in the direction of maximum gain of its antenna to a point where the tag is just identified. The distance d between the antenna of the interrogator and the tag shall be measured. If the distance between the tag and the interrogator is too great to fit within the anechoic chamber, an attenuator may be inserted between the interrogator and its antenna.
- Step 3: The tag shall then be moved to a new position that is at a distance of $0,7 d$ from the interrogator in the direction of maximum gain of its antenna.
- Step 4: A signal generator fitted with a directive antenna (e.g. horn antenna) shall be set up in accordance with figure 14 and its transmission directed at the antenna of the interrogator.
- Step 5: The signal generator shall be adjusted to radiate an un-modulated signal at test frequencies of approximately 2 MHz, 5 MHz and 10 MHz above the centre frequency of the interrogator.
- Step 6: At each test frequency the level of the signal generator shall be increased until the interrogator just ceases to identify the tag with approximately 50 % success rate. The level of the signal generator shall then be reduced in 1 dB steps until the interrogator just identifies the tag again.

- Step 7: The interrogator shall be removed and replaced by a measurement antenna connected to a measuring receiver set to a resolution bandwidth of 100 kHz. At each test frequency the level of signal from the signal generator received at the measuring receiver shall be recorded.
- Step 8: The tests shall be repeated at approximately, -2 MHz, -5 MHz and -10 MHz from the carrier frequency of the interrogator.
- Step 9: The absolute levels of the signals received by the measurement receiver from the signal generator shall be corrected using formula (4).

$$S_{BL} = P_{MR} - G_{MR} \quad (4)$$

Where:

- S_{BL} is the blocking level in dBm.
- P_{MR} is the signal strength received at the measurement receiver.
- G_{MR} is the antenna gain of the measurement receiver antenna in dBi.

The highest corrected power level in dBm referred to the input to the interrogator at which it is just possible to identify a tag shall be not less than the limit specified in clause 4.4.2.3.

- Step 10: If the interrogator supports multiple bands then steps 1 to 9 shall be repeated respectively.

5.6.2.3 Method 2: Conducted method of measurement

Where the interrogator is fitted with an external antenna connector, the measurement may be made using a modified tag that provides a hard-wire connection.

- Step 1: An interrogator shall be set up to operate at its maximum output power on a known channel (channels are defined in clause 4.2.2) in accordance with figure 15. Furthermore, the interrogator shall be set up to operate in either the lower band to use a tag offset frequency to approximately 300 kHz, or in the upper band to use a tag offset of approximately 600 kHz.
- Step 2: To check that the tag is not activated by the interrogator via attenuator 2, attenuator 1 shall be removed from the circuit. The open port of circulators A and B shall each be terminated by a 50 Ω load resistor. With the signal generator switched off, the interrogator shall be switched on at its maximum output power. Attenuator 2 shall be increased until the interrogator just ceases to identify the tag with approximately 50 % success rate. The value of attenuator 2 shall be noted. For the remainder of the test attenuator 2 shall not be reduced below this value.
- Step 3: The 50 Ω load resistors shall be removed from circulators A and B and replaced by attenuator 1. With the signal generator switched off, the interrogator shall be switched on again at its maximum output power. Attenuator 1 shall be increased until it is just possible for the interrogator to read the tag. The setting of the attenuator 1 shall then be reduced by 10 dB to ensure that the tag remains fully activated.
- Step 4: With the signal generator switched off, attenuator 2 shall be increased until the interrogator is just able to identify the tag with approximately 50 % success rate. Attenuator 2 shall then be reduced by 3 dB to ensure that the interrogator receives an acceptable signal level from the tag.
- Step 5: The signal generator shall be adjusted to produce an un-modulated signal at test frequencies of approximately 2 MHz, 5 MHz and 10 MHz above the carrier frequency of the interrogator.
- Step 6: At each test frequency the level of the signal generator shall be increased until the interrogator just ceases to identify the tag with approximately 50 % success rate. The level of the signal generator shall then be reduced in 1 dB steps until the interrogator just identifies the tag again. The level of signals from the signal generator at which the interrogator just identifies the tag shall be recorded.
- Step 7: The tests shall be repeated at approximately -2 MHz, -5 MHz and -10 MHz from the centre frequency of the interrogator.

- Step 8: The recorded signals from the signal generator shall be corrected to compensate for any losses in both circulator A and in the power splitter to give the corrected signals received at the input to the interrogator.
- Step 9: At each test frequency the blocking or desensitization shall be recorded in the test report as the highest level in dBm of the unwanted signal at which it is just possible to identify a tag and shall not be less than the limits specified in clause 4.4.2.3.
- Step 10: If the interrogator supports multiple bands then steps 1 to 9 shall be repeated respectively.

5.6.3 Receiver spurious response rejection

5.6.3.1 General

This measurement is required to ensure satisfactory operation of equipment in accordance with the band plan. Two alternative methods are specified:

- Method 1: without antenna connector
- Method 2: with antenna connector

5.6.3.2 Method 1 of measuring radiated signals

- Step 1: An interrogator shall be set up to operate at its maximum output power on a known channel (channels are defined in clause 4.2.2) either in an anechoic chamber or on an open air test site as specified in annex B. Furthermore, the interrogator shall be set up to operate in either the lower band to use a tag offset frequency to approximately 300 kHz, or in the upper band to use a tag offset of approximately 600 kHz. The interrogator shall be connected to an antenna with combined Tx and Rx functionality.
- Step 2: A tag with a sensitivity of better than -15 dBm shall be selected. With the tag in its preferred orientation it shall be moved slowly towards the interrogator in the direction of maximum gain of its antenna to a point where the tag is just identified. The distance d between the antenna of the interrogator and the tag shall be measured. If the distance between the tag and the interrogator is too great to fit within the anechoic chamber, an attenuator may be inserted between the interrogator and its antenna.
- Step 3: The tag shall then be moved to a new position that is at a distance of $0,7 d$ from the interrogator in the direction of maximum gain of its antenna.
- Step 4: A signal generator fitted with a directive antenna (e.g. horn antenna) shall be set up in accordance with figure 14 and its transmission directed at the antenna of the interrogator.
- Step 5: The signal generator shall be adjusted to radiate an un-modulated signal at test frequencies of approximately carrier frequency $f_c / 2$ and carrier frequency $f_c / 3$.
- Step 6: At each test frequency the level of the signal generator shall be increased until the interrogator just ceases to identify the tag with approximately 50 % success rate. The level of the signal generator shall then be reduced in 1 dB steps until the interrogator just identifies the tag again.
- Step 7: The interrogator shall be removed and replaced by a measurement antenna connected to a measuring receiver set to a resolution bandwidth of 100 kHz. At each test frequency the level of signal from the signal generator received at the measuring receiver shall be recorded.
- Step 8: The spurious response rejection shall be recorded in the test report as the highest level in dBm at the input to the interrogator of the unwanted signal at which it is just possible to identify a tag.
- The absolute levels of the signals received by the measurement receiver from the signal generator shall be corrected using formula (5).

$$S_{BL} = P_{MR} - G_{MR} \quad (5)$$

Where:

- S_{BL} is the blocking level in dBm.
- P_{MR} is the signal strength received at the measurement receiver.
- G_{MR} is the antenna gain of the measurement receiver antenna in dBi.

The highest corrected power level in dBm referred to the input to the interrogator at which it is just possible to identify a tag shall be not less than the limit specified in clause 4.4.4.3.

Step 9: If the interrogator supports multiple bands then steps 1 to 9 shall be repeated respectively.

5.6.3.3 Method 2: Conducted method of measurement

Where the interrogator is fitted with an external antenna connector, the measurement may be made using a modified tag that provides a hard-wire connection.

- Step 1: An interrogator shall be set up to operate at its maximum output power on a known channel (channels are defined in clause 4.2.2) in accordance with figure 15. Furthermore, the interrogator shall be set up to operate in either the lower band to use a tag offset frequency to approximately 300 kHz, or in the upper band to use a tag offset of approximately 600 kHz.
- Step 2: To check that the tag is not activated by the interrogator via attenuator 2, attenuator 1 shall be removed from the circuit. The open port of circulators A and B shall each be terminated by a 50 Ω load resistor. With the signal generator switched off, the interrogator shall be switched on at its maximum output power. Attenuator 2 shall be increased until the interrogator just ceases to identify the tag with approximately 50 % success rate. The value of attenuator 2 shall be noted. For the remainder of the test attenuator 2 shall not be reduced below this value.
- Step 3: The 50 Ω load resistors shall be removed from circulators A and B and replaced by attenuator 1. With the signal generator switched off, the interrogator shall be switched on again at its maximum output power. Attenuator 1 shall be increased until it is just possible for the interrogator to read the tag. The setting of the attenuator 1 shall then be reduced by 10 dB to ensure that the tag remains fully activated.
- Step 4: With the signal generator switched off, attenuator 2 shall be increased until the interrogator is just able to identify the tag with approximately 50 % success rate. Attenuator 2 shall then be reduced by 3 dB to ensure that the interrogator receives an acceptable signal level from the tag.
- Step 5: The signal generator shall be adjusted to radiate an un-modulated signal at test frequencies of approximately carrier frequency $f_c / 2$ and carrier frequency $f_c / 3$.
- Step 6: At each test frequency the level of the signal generator shall be increased until the interrogator just ceases to identify the tag with approximately 50 % success rate. The level of the signal generator shall then be reduced in 1 dB steps until the interrogator just identifies the tag again. The level of signals from the signal generator at which the interrogator just identifies the tag shall be recorded.
- Step 7: The recorded signals from the signal generator shall be corrected to compensate for any losses in both circulator A and in the power splitter to give the corrected signals received at the input to the interrogator.
- Step 8: At each test frequency the spurious response rejection shall be recorded in the test report as the highest corrected level in dBm of the unwanted signal at which it is just possible to identify a tag and the levels shall be not less than the limits specified in clause 4.4.4.3.
- Step 9: If the interrogator supports multiple bands then steps 1 to 8 shall be repeated respectively.

5.6.4 Receiver sensitivity

5.6.4.1 Method of measurement

This measurement shall be performed as conducted measurement only. For equipment intended for use with an integral antenna, and not equipped with a 50 Ω RF output connector, the test fixture as described in clause 5.4.5 shall be applied.

The interrogator shall be setup to communicate in one channel as defined in figure 1 for the lower band or figure 2 for the upper band using the maximum transmit power according to its Interrogator category. The tag shall be stimulated to respond with a subcarrier of approximately 300 kHz for the lower band and 600 kHz, or the highest tag offset supported by the interrogator, for the upper band.

NOTE: For testing of ISO/IEC 18000-63 [i.20] compliant products it is recommended to use the protocol settings details as described for the ISO/IEC 18046-2 [i.17] reader sensitivity test. Values like T_{ari} , RT_{cal} , TR_{cal} , BLF, DR and M should be recorded.

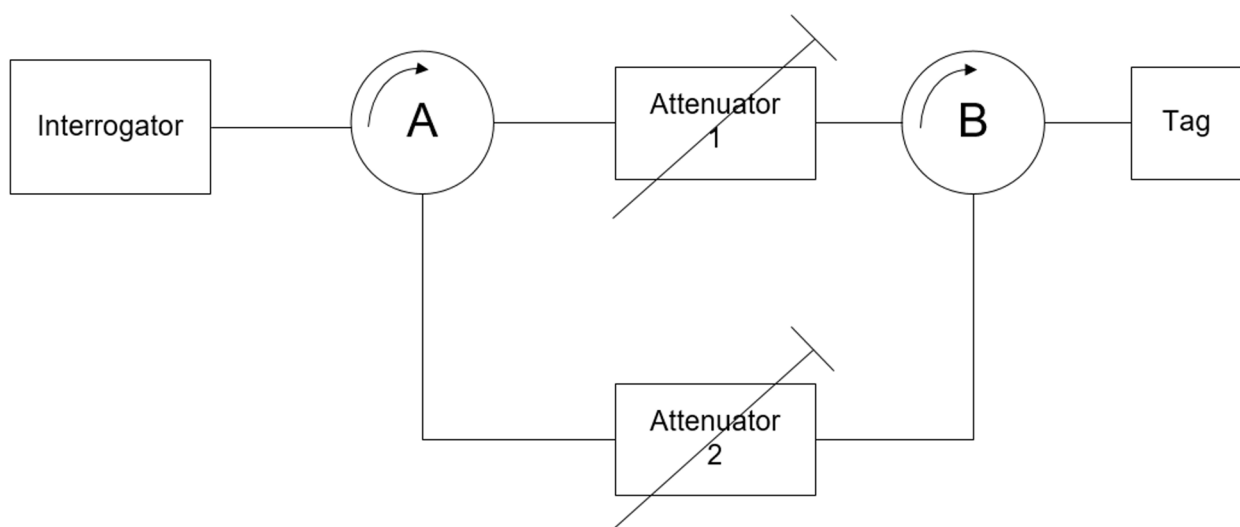

Figure 15a: Conducted test set up for receiver sensitivity



Figure 15b: Conducted test set up for receiver sensitivity with (emulated) tag with variable backscatter

The test procedure contains the following steps:

- Step 1: An interrogator shall be configured to operate in the lower band in accordance with figure 15a or figure 15b. The interrogator shall configure the tag offset frequency to approximately 300 kHz for lower band and 600 kHz, or the highest tag offset supported by the interrogator, for the upper band.

- Step 2: The interrogator output power shall be adjusted to the maximum allowed for its Interrogator category and Antenna beam-width limits.
- Step 3: The tag backscatter signal and optionally a phase shift shall be adjusted until the interrogator is just able to identify the tag with approximately 50 % success rate.
- Step 4: The receiver sensitivity shall be recorded in the test report as the level of the tag signal, covering **both sidebands** and excluding the carrier, in dBm at the input of the reader receiver, where it is just possible to identify a tag at higher than or equal to 50 % success rate. The levels shall comply with the limits specified in clause 4.4.5.3 according to its Interrogator category.

5.6.5 Receiver radio-frequency intermodulation

5.6.5.1 General

This measurement is required to ensure satisfactory operation of equipment in accordance with the band plan. Two alternative methods are specified:

- Method 1: without antenna connector
- Method 2: with antenna connector

5.6.5.2 Method 1: Method of measuring radiated signals

- Step 1: An interrogator shall be set up to operate at its maximum output power on a known channel (channels are defined in clause 4.2.2) either in an anechoic chamber or on an open air test site as specified in annex B. Furthermore, the interrogator shall be set up to operate in either the lower band to use a tag offset frequency to approximately 300 kHz, or in the upper band to use a tag offset of approximately 600 kHz. The interrogator shall be connected to an antenna with combined Tx and Rx functionality.
- Step 2: A tag with a sensitivity of better than -15 dBm shall be selected. With the tag in its preferred orientation it shall be moved slowly towards the interrogator in the direction of maximum gain of its antenna to a point where the tag is just identified. The distance d between the antenna of the interrogator and the tag shall be measured. If the distance between the tag and the interrogator is too great to fit within the anechoic chamber, an attenuator may be inserted between the interrogator and its antenna.
- Step 3: The tag shall then be moved to a new position that is at a distance of $0,7 d$ from the interrogator in the direction of maximum gain of its antenna.
- Step 4: A first and second signal generator shall be connected to a combiner this fitted with a directive antenna (e.g. horn antenna) antenna shall be set up in accordance with figure 15c and its transmission directed at the antenna of the interrogator.

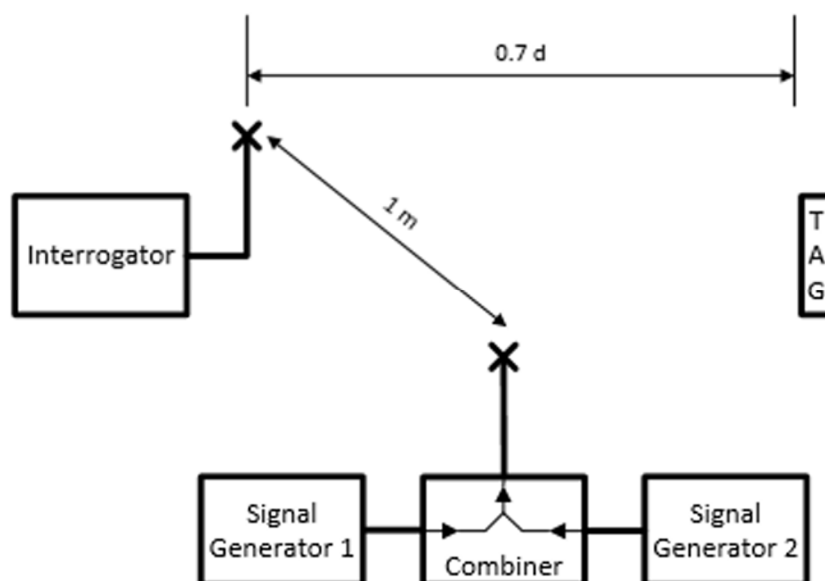

Figure 15c: Radiated test set up for intermodulation response rejection

- Step 5: The first signal generator shall be adjusted to radiate a signal at a test frequency of $f_c + 0,6$ MHz that lies at the mid-point of the upper adjacent channel and the signal shall be an AM modulated sine wave to a depth of 80 % at a frequency of 40 kHz.
- Step 6: The second signal generator shall be adjusted to radiate a signal at a test frequency $f_c + 1,2$ MHz at the same level as the first signal generator.
- Step 7: The level of the signal generators shall be increased, keeping the levels the same, until the interrogator just ceases to identify the tag with approximately 50 % success rate. The level of the signal generators shall then be reduced in 1 dB steps until the interrogator just identifies the tag again.
- Step 8: The interrogator shall be removed and replaced by a measurement antenna connected to a measurement receiver set to a resolution bandwidth of 100 kHz. The level of signal from the first signal generator received at the measurement receiver shall be recorded.
- Step 9: The absolute levels of the signals received by the measurement receiver from the signal generator shall be corrected using formula (6).

$$S_{ACH} = P_{MR} - G_{MR} \quad (6)$$

Where:

- S_{ACH} is the adjacent channel selectivity in dBm.
- P_{MR} is the signal strength received at the measurement receiver.
- G_{MR} is the antenna gain of the measurement receiver antenna in dBi.

The corrected power level for each measurement shall be not less than the limit specified in clause 4.4.6.3.

- Step 10: If the interrogator supports multiple bands then steps 1 to 9 shall be repeated respectively.

5.6.5.3 Method 2: Conducted method of measurement

Where the interrogator is fitted with an external antenna connector, the measurement may be made using a modified tag that provides a hard-wire connection.

- Step 1: An interrogator shall be set up to operate at its maximum output power on a known channel (channels are defined in clause 4.2.2) in accordance with figure 15d below. Furthermore, the interrogator shall be set up to operate in either the lower band to use a tag offset frequency to approximately 300 kHz, or in the upper band to use a tag offset of approximately 600 kHz.

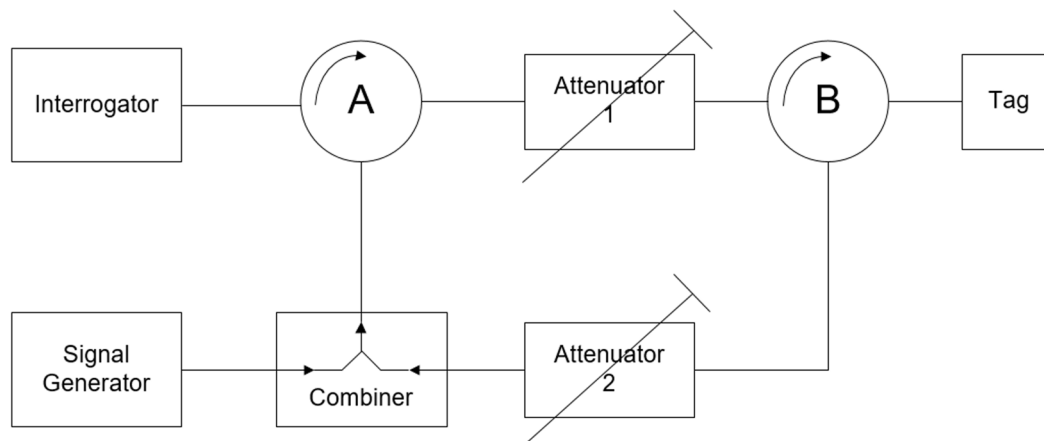

Figure 15d: Conducted test set up for intermodulation response rejection

- Step 2: To check that the tag is not activated by the interrogator via attenuator 2, attenuator 1 shall be removed from the circuit. The open port of circulators A and B shall each be terminated by a 50 Ω load resistor. With the signal generator switched off, the interrogator shall be switched on at its maximum output power. Attenuator 2 shall be increased until the interrogator just ceases to identify the tag with approximately 50 % success rate. The value of attenuator 2 shall be noted. For the remainder of the test attenuator 2 shall not be reduced below this value.
- Step 3: The 50 Ω load resistors shall be removed from circulators A and B and replaced by attenuator 1. With the signal generator switched off, the interrogator shall be switched on again at its maximum output power. Attenuator 1 shall be increased until it is just possible for the interrogator to read the tag. The setting of the attenuator 1 shall then be reduced by 10 dB to ensure that the tag remains fully activated.
- Step 4: With the signal generator switched off, attenuator 2 shall be increased until the interrogator is just able to identify the tag with approximately 50 % success rate. Attenuator 2 shall then be reduced by 3 dB to ensure that the interrogator receives an acceptable signal level from the tag.
- Step 5: The first signal generator shall be adjusted to generate a signal at a test frequency $f_c + 0,6$ MHz for lower band and $f_c + 1,2$ MHz for the upper band test. The signal shall be an AM sine wave modulated to a depth of 80 % at a frequency of 40 kHz.
- Step 6: The second signal generator shall be adjusted to generate a signal at a test frequency $f_c + 1,2$ MHz for lower band and $f_c + 2,4$ MHz for upper band tests, at the same level as the first signal generator.
- Step 7: The level of the signal generators shall be increased, keeping the levels the same, until the interrogator just ceases to identify the tag with approximately 50 % success rate. The level of the signal generators shall then be reduced in 1 dB steps until the interrogator just identifies the tag again. The level of signal from the first signal generator shall be recorded.
- Step 8: The level of signal from the signal generators shall be adjusted to compensate for the losses in both circulator A and the power splitter to give the corrected signal received in dBm at the input of the interrogator.
- Step 9: Steps 1 to 8 shall be repeated on the upper band using a tag offset frequency of approximately 600 kHz and signal generators configured to $f_c + 1,2$ MHz and $f_c + 2,4$ MHz respectively.

Step 10: The absolute level of the signals from the signal generator referred to the input of the interrogator in dBm shall be not less than the limit specified in clause 4.4.6.3.

Step 11: If the interrogator supports multiple bands then steps 1 to 10 shall be repeated respectively.

The results shall be recorded in the test report.

5.7 Essential tag test suites

5.7.1 Tag radiated power (e.r.p.)

5.7.1.1 Method of measurement

These tests shall be performed only in the bands in which the tag is intended to operate.

The measurement shall be performed using an interrogator, or an equivalent test fixture, and antenna under the same set-up conditions as used for the measurement of effective radiated power in clause 5.5.3. The intentional emissions from the tag shall be measured as:

either:

- a) the power from a tag configured to emit an un-modulated sub-carrier; or
- b) the power from a tag configured to emit a continuous modulated response.

5.7.1.1.1 Measurement setup

On default a measurement antenna shall be positioned at a distance of 1 m from the tag in the direction of maximum gain of the antenna of the interrogator. The measurement antenna shall be connected to the measuring receiver. The measurement antenna shall be orientated to obtain maximum signal. A diagram of the test configuration is shown in figure 16.

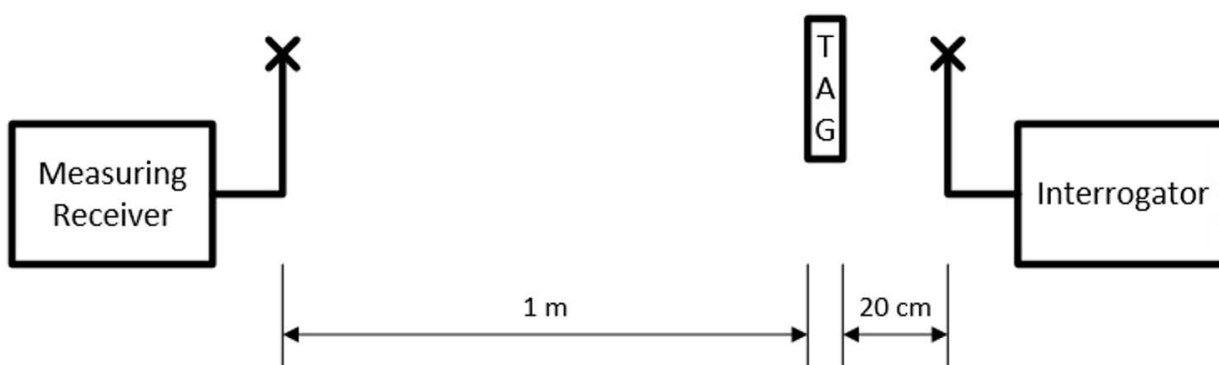

Figure 16: Measurement of tag emissions

For tags fitted with metal backplanes or similar material the configuration should be as the diagram in figure 16a with an interrogator angle of 0° to 60° between the tag-interrogator to tag-receiver line, whereas the receiver antenna shall be placed in the direction of maximum gain of the tag.

Metal backplanes used for testing shall be at least 40 cm in diameter, whereas any edge shall be at least 20 cm away from the tag.

For tag tests according to clause 5.7 a measurement chamber as in annex A shall be used, however, such measurement chamber may be smaller than 3 m, provided that there is free space of at least $\frac{2D^2}{\lambda}$ around the antennas footprint of the test equipment and the DUT (Tag). For $f = 921$ MHz and $D = 0,25$ m this means:

$$\frac{2D^2}{\lambda} = 2D^2 \frac{f}{c_0} = 2 \cdot 0,25^2 \frac{921 \cdot 10^6}{3 \cdot 10^8} \text{ m} = 0,384 \text{ m.}$$

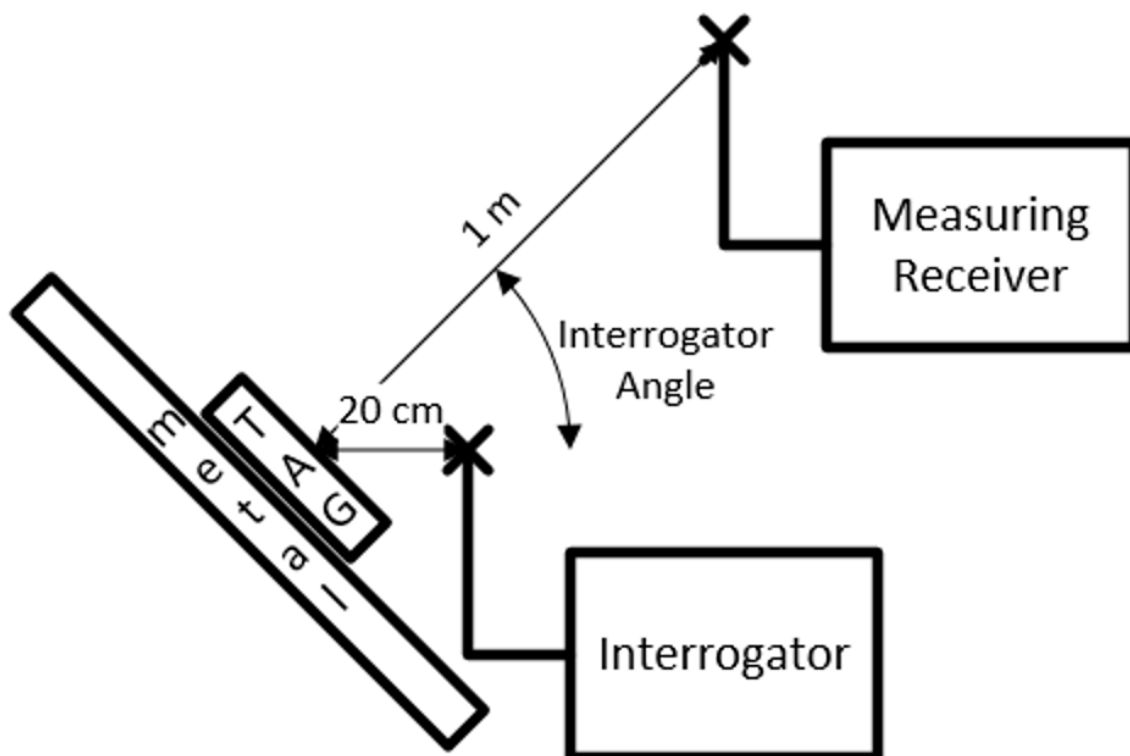

Figure 16a: Measurement of tag emissions with metal

5.7.1.2 Method of measuring the power in an un-modulated sub-carrier, clause 5.7.1.1 a)

This method applies to tags that may be set to emit an un-modulated sub-carrier.

- Step 1: On a test site, selected from annex B, the interrogator shall be placed at the specified height on a non-conducting support and in the position closest to normal use as declared by the manufacturer.
- Step 2: In each band at which the tag is capable of operating, the interrogator shall be set to transmit at a single carrier frequency "fc" on a high power channel as determined by the test house. The interrogator shall provide an initial "wake up signal" to activate the tag followed by a continuous carrier at a power level of 2 W e.r.p.
- Step 3: The tag under test shall be positioned in free space at a distance of 20 cm from the antenna of the interrogator in its direction of maximum gain and in an orientation that provides optimum coupling with the transmitted signal. For the lower band the tag shall be configured to emit an un-modulated sub-carrier at an approximate frequency of $f_c \pm 300$ kHz, or such other frequency as declared by the manufacturer, (see figure 8). For the upper band the tag shall be configured to emit an un-modulated sub-carrier at an approximate frequency of $f_c \pm 600$ kHz, or such other frequency as declared by the manufacturer (see figure 9).
- Step 4: The measurement shall be carried out using a measuring receiver set to the following values:
- a) Resolution bandwidth: 1 kHz.

- b) Video bandwidth: Equal to the RBW.
- c) Sweep time: Auto.
- d) Span: 1 MHz.
- e) Trace mode: Max. hold sufficient to capture all emissions.
- f) Detection mode: Average.

- Step 5: The tag, a measurement antenna and an interrogator antenna shall be setup according to clause 5.7.1.1bis.
- Step 6: The measuring receiver shall be tuned to the frequency of the lower sub-carrier of the tag and the level of the combined emissions from both the tag and interrogator shall be recorded. The same procedure shall be repeated for the upper sub-carrier.
- Step 7: Without moving the test antenna and the interrogator, the tag shall be removed from the proximity of the test area. The measuring receiver shall be tuned to the same frequencies as in step 6 and the levels of the emissions from the interrogator shall be recorded.
- Step 8: The power emitted by the tag shall be determined by deducting the levels in μW recorded in step 7 from the corresponding levels recorded in step 6, whereas the pathloss and receive antenna gain shall be considered to get the emissions levels of the tag at the tag position. The maximum value of the upper and lower sub-carrier frequencies shall be recorded as the emitted power.
- Step 9: In normal operation the emissions from the tag in the lower band are spread across 300 kHz in the sidebands on both sides of f_c . For the upper band the emissions from the tag are spread across 600 kHz in the sidebands on both sides of f_c . (See figures 8 and 9.) The power emitted shall be calculated as power spectrum density in 100 kHz using formula (7):

$$A = P_c + 10 \log \frac{100 \text{ kHz}}{BW} \quad (7)$$

Where:

- P_c is the radiated power of the unmodulated sub-carrier from the tag;
- A is the absolute value of the power spectrum density referred to a 100 kHz reference bandwidth;
- BW is the bandwidth occupied by the tag response in a single sideband as defined in step 9.

5.7.1.3 Method of measuring the power in a modulated sub-carrier, clause 5.7.1.1 b)

This method applies to tags that are able only to emit a modulated sub-carrier.

- Step 1: On a test site, selected from annex B, the interrogator shall be placed at the specified height on a non-conducting support and in the position closest to normal use as declared by the manufacturer.
- Step 2: In each band in which the tag is capable of operating the interrogatory shall be set to transmit at a single carrier frequency " f_c " on a high power channel as determined by the test house. The interrogator shall provide an initial "wake up command" to activate the tag followed by a continuous carrier at a power level of 2 W e.r.p.
- Step 3: The tag under test shall be positioned in free space at a distance of 20 cm from the antenna of the interrogator in its direction of maximum gain and in an orientation that provides optimum coupling with the transmitted signal. The tag shall be configured to emit a continuous modulated response as described in clause 5.4.9. For the lower band this response shall be centred at an approximate offset frequency of $f_c \pm 300$ kHz, or such other frequency as declared by the manufacturer. For the upper band this response shall be centred at an approximate offset frequency of $f_c \pm 600$ kHz, or such other frequency as declared by the manufacturer.

- Step 4: The measurement shall be carried out using a measuring receiver set to the following values:
- a) Resolution bandwidth: 1 kHz.
 - b) Video bandwidth: Equal to the RBW.
 - c) Sweep time: Auto.
 - d) Span: 1 MHz.
 - e) Trace mode: Max. hold sufficient to capture all emissions.
 - f) Detection mode: Average.
- Step 5: The tag, a measurement antenna and an interrogator antenna shall be setup according to clause 5.7.1.1bis.
- Step 6: The measuring receiver shall be tuned to the frequency of the lower sub-carrier of the tag and the level of the combined emissions from both the tag and interrogator shall be recorded. The same procedure shall be repeated for the upper sub-carrier.
- Step 7: Without moving the test antenna and the interrogator, the tag shall be removed from the proximity of the test area. A plot shall be made of the emissions from the interrogator in increments of 3 kHz over the same frequency range.
- Step 8: The power emitted by the tag shall be determined by deducting the levels in μW recorded in step 7 from the corresponding levels recorded in step 6, whereas the pathloss and receive antenna gain shall be considered to get the emissions levels of the tag at the tag position. The maximum value of the upper and lower sub-carrier frequencies shall be recorded as the emitted power.
- Step 9: Steps 6 to 8 shall be repeated across the upper side-band. For the lower band this shall cover the range $f_c + 400 \text{ kHz}$ to $f_c + 100 \text{ kHz}$. For the upper band this shall cover the range $f_c + 800 \text{ kHz}$ to $f_c + 200 \text{ kHz}$. The higher of the values obtained in the lower and upper sidebands shall be recorded as the radiated power of the tag.
- Step 10: The radiated power of the tag as derived in step 9 may be referred to a 100 kHz bandwidth using formula (8):

$$A = P_c + 10 \log \frac{100 \text{ kHz}}{BW} \quad (8)$$

Where:

- P_c is the radiated power of the tag;
- A is the absolute value of the power spectrum density referred to a 100 kHz reference bandwidth;
- BW is the bandwidth occupied by the tag response in a single sideband as defined in step 9.

The results shall be recorded in the test report.

5.7.2 Unwanted emissions

5.7.2.1 Method of measurement

The measurement shall be performed using an interrogator, or equivalent test fixture, and antenna under the same set-up conditions as used for the measurement of effective radiated power in clause 5.5.3.

In the event that the carrier signal from the interrogator is too high for the dynamic range of the measurement receiver, a notch filter may optionally be connected between the measurement antenna and the measurement receiver to attenuate the carrier signal. This may be used for measurements at greater than 2 MHz from the carrier. The filter shall have a loss of less than 3 dB at ± 1 MHz from f_c .

- Step 1: On a test site, selected from annex B, the interrogator shall be placed at the specified height on a non-conducting support and in the position closest to normal use as declared by the manufacturer.

- Step 2: In each band at which the tag is capable of operating the interrogator shall be set to transmit at a single carrier frequency " f_c " on a high power channel as determined by the test house. The interrogator shall provide an initial "wake up response" to activate the tag followed by a continuous carrier at a power level of 2 W e.r.p.
- Step 3: The tag under test shall be positioned at a distance of 20 cm from the antenna of the interrogator in its direction of maximum gain and in an orientation that provides optimum coupling with the transmitted signal. The tag shall be configured to emit a continuous modulated response as described in clause 5.4.9 at an approximate offset frequency of either $f_c \pm 300$ kHz for the lower band or ± 600 kHz for the upper band or such other frequency as declared by the manufacturer.
- Step 4: The measurement shall be carried out using a measuring receiver set to the following values:
- Resolution bandwidth: In accordance with the figures 17 or 18 as applicable.
 - Video bandwidth: Equal to the RBW.
 - Sweep time: Auto.
 - Span: As defined by the relevant frequency ranges in figures 17 or 18 as applicable.
 - Trace mode: Average.
 - Detection mode: Average.

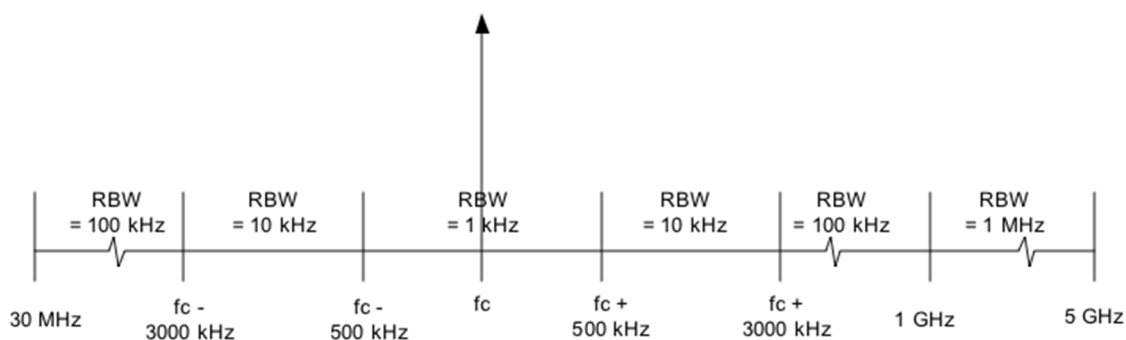

NOTE: See clause 5.7.1 for measurement of the intentional power radiated by tags.

Figure 17: Resolution bandwidths for tag emissions in the lower band

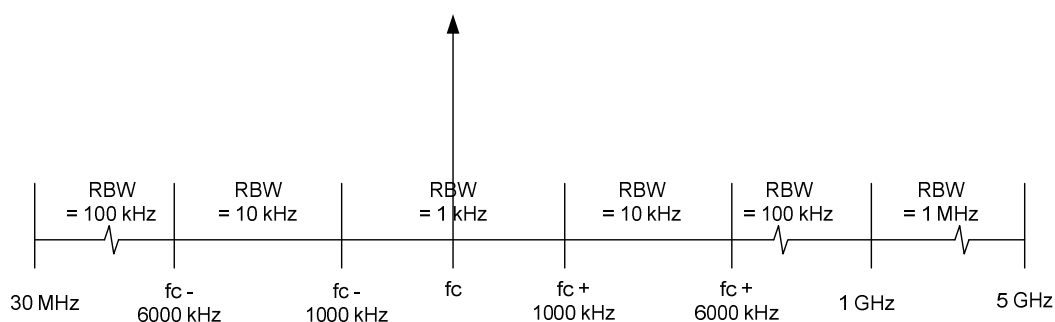

NOTE: See clause 5.7.1 for measurement of the intentional power radiated by tags.

Figure 18: Resolution bandwidths for tag emissions in the upper band

- Step 5: The tag, a measurement antenna and an interrogator antenna shall be setup according to clause 5.7.1.1.1.

- Step 6: The measuring receiver shall be set to the resolution bandwidths specified in figures 17 or 18 as applicable, which are the same as the reference bandwidths. Alternatively a lower resolution bandwidth may be used to improve the measurement accuracy.
- Step 7: A plot of the combined emissions from both the tag and interrogator shall be recorded.
- Step 8: The tag shall be removed from the proximity of the test area. Without moving the test antenna and the interrogator a plot shall again be taken across the same frequency range.
- Step 9: Where the specified resolution bandwidths in figures 17 or 18 are used, the unwanted emissions from the tag shall be determined by deducting the levels in μW recorded in step 8 from levels recorded in the step 7, whereas the pathloss and receive antenna gain shall be considered to get the emissions levels of the tag at the tag position.
- Step 10: At frequencies outside those measured in clause 5.7.1, the discrete spectral components within each reference band specified in figures 17 or 18 shall be recorded. The recorded values shall not exceed the limits specified for the operating mode in table 2.

Annex A (informative): Relationship between the present document and the essential requirements of Directive 2014/53/EU

The present document has been prepared under the Commission's standardisation request C(2015) 5376 final [i.10] to provide one voluntary means of conforming to the essential requirements of Directive 2014/53/EU on the harmonisation of the laws of the Member States relating to the making available on the market of radio equipment and repealing Directive 1999/5/EC [i.3].

Once the present document is cited in the Official Journal of the European Union under that Directive, compliance with the normative clauses of the present document given in table A.1 confers, within the limits of the scope of the present document, a presumption of conformity with the corresponding essential requirements of that Directive, and associated EFTA regulations.

Table A.1: Relationship between the present document and the essential requirements of Directive 2014/53/EU

Harmonised Standard ETSI EN 302 208					
Requirement				Requirement Conditionality	
No	Description	Essential requirements of Directive	Clause(s) of the present document	U/C	Condition
1	Designated frequencies	3.2	4.2.2	C	Applies to interrogators
2	Frequency error	3.2	4.3.1	C	Applies to interrogators
3	Frequency stability under low voltage conditions	3.2	4.3.2	C	Applies to battery powered interrogators
4	Effective radiated power	3.2	4.3.3	C	Applies to interrogators
5	Transmitter antenna beam-width	3.2	4.3.4	C	Applies to interrogator antennas
6	Transmission spectrum masks	3.2	4.3.5	C	Applies to interrogators
7	Transmitter spurious emissions	3.2	4.3.6	C	Applies to interrogators
8	Transmission times	3.2	4.3.7	C	Applies to interrogators in the lower band
9	Receiver adjacent channel selectivity	3.2	4.4.1	C	Applies to interrogators
10	Receiver blocking or desensitization	3.2	4.4.2	C	Applies to interrogators
11	Receiver spurious emissions	3.2	4.4.3	C	Applies to interrogators
12	Receiver spurious response rejection	3.2	4.4.4	C	Applies to interrogators
13	Receiver sensitivity	3.2	4.4.5	C	Applies to interrogators
14	Receiver radio-frequency intermodulation	3.2	4.4.6	C	Applies to interrogators
15	Tag radiated power	3.2	4.5.1	C	Applies to tags
16	Tag unwanted emissions	3.2	4.5.2	C	Applies to tags

Key to columns:

Requirement:

No A unique identifier for one row of the table which may be used to identify a requirement.

Description A textual reference to the requirement.

Essential requirements of Directive

Identification of article(s) defining the requirement in the Directive.

Clause(s) of the present document

Identification of clause(s) defining the requirement in the present document unless another document is referenced explicitly.

Requirement Conditionality:

U/C	Indicates whether the requirement is unconditionally applicable (U) or is conditional upon the manufacturer's claimed functionality of the equipment (C).
Condition	Explains the conditions when the requirement is or is not applicable for a requirement which is classified "conditional".

Presumption of conformity stays valid only as long as a reference to the present document is maintained in the list published in the Official Journal of the European Union. Users of the present document should consult frequently the latest list published in the Official Journal of the European Union.

Other Union legislation may be applicable to the product(s) falling within the scope of the present document.

Annex B (normative): Radiated measurement

B.1 Test sites and general arrangements for measurements involving the use of radiated fields

B.1.1 General

This annex is applicable to the assessment of data or equipment providing a specific response.

It covers test sites and methods to be used with integral antenna equipment or equipment having an antenna connector. This annex introduces three most commonly available test sites, an anechoic chamber, an anechoic chamber with a ground plane and an Open Area Test Site (OATS), which may be used for radiated tests. These test sites are generally referred to as free field test sites. Both absolute and relative measurements can be performed in these sites. Where absolute measurements are to be carried out, the chamber shall be verified. A detailed verification procedure shall be in accordance with ETSI TR 102 273 [i.13].

NOTE: To ensure reproducibility and tractability of radiated measurements only these test sites should be used in measurements in accordance with the present document.

B.1.2 Anechoic chamber

An anechoic chamber is an enclosure, usually shielded, whose internal walls, floor and ceiling are covered with radio absorbing material, normally of the pyramidal urethane foam type. The chamber usually contains an antenna support at one end and a turntable at the other. A typical anechoic chamber is shown in figure B.1.

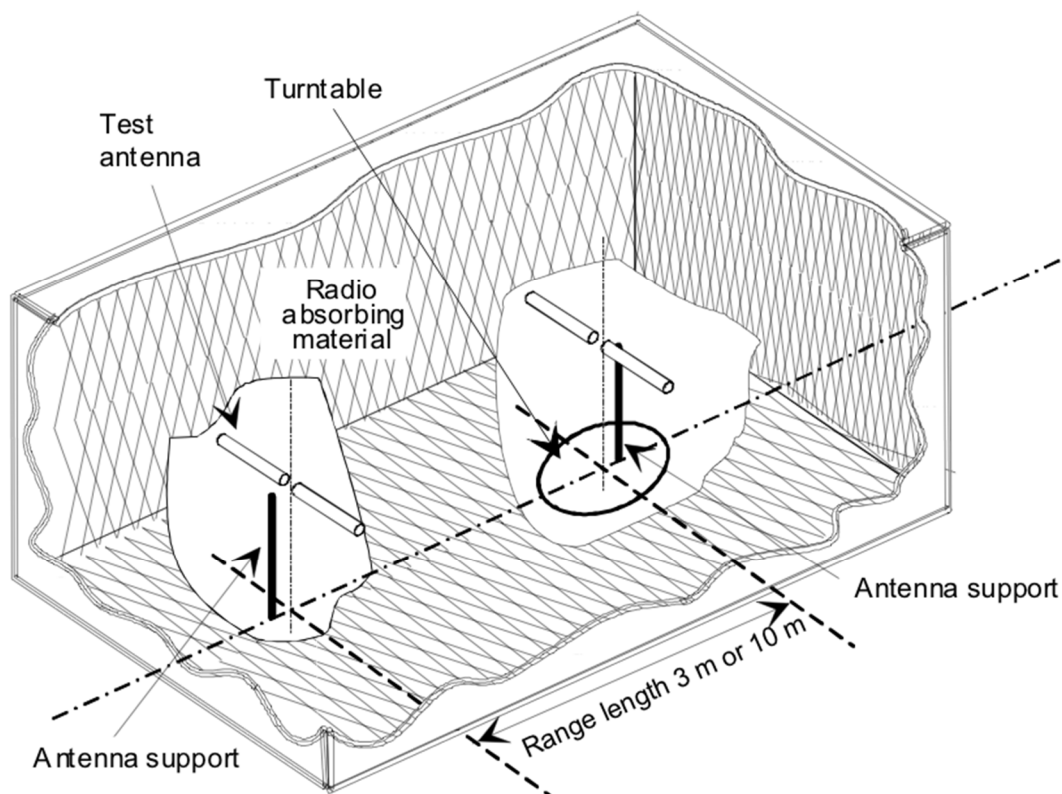

Figure B.1: A typical anechoic chamber

The chamber shielding and radio absorbing material work together to provide a controlled environment for testing purposes. This type of test chamber attempts to simulate free space conditions.

The shielding provides a test space, with reduced levels of interference from ambient signals and other outside effects, whilst the radio absorbing material minimizes unwanted reflections from the walls and ceiling which can influence the measurements. In practice it is relatively easy for shielding to provide high levels (80 dB to 140 dB) of ambient interference rejection, normally making ambient interference negligible.

A turntable is capable of rotation through 360° in the horizontal plane and it is used to support the test sample (EUT) at a suitable height (e.g. 1 m) above the ground plane. The chamber shall be large enough to allow the measuring distance of at least 3 m or $2(d_1 + d_2)^2 / \lambda$ (m), whichever is greater (see clause B.2.5). The distance used in actual measurements shall be recorded with the test results.

The anechoic chamber generally has several advantages over other test facilities. There is minimal ambient interference, minimal floor, ceiling and wall reflections and it is independent of the weather. It does however have some disadvantages, which include limited measuring distance and limited lower frequency usage due to the size of the pyramidal absorbers. To improve low frequency performance, a combination structure of ferrite tiles and urethane foam absorbers is commonly used.

All types of emission, sensitivity and immunity testing can be carried out within an anechoic chamber without limitation.

B.1.3 Anechoic chamber with a conductive ground plane

An anechoic chamber with a conductive ground plane is an enclosure, usually shielded, whose internal walls and ceiling are covered with radio absorbing material, normally of the pyramidal urethane foam type. The floor, which is metallic, is not covered and forms the ground plane. The chamber usually contains an antenna mast at one end and a turntable at the other. A typical anechoic chamber with a conductive ground plane is shown in figure B.2.

This type of test chamber attempts to simulate an ideal Open Area Test Site whose primary characteristic is a perfectly conducting ground plane of infinite extent.

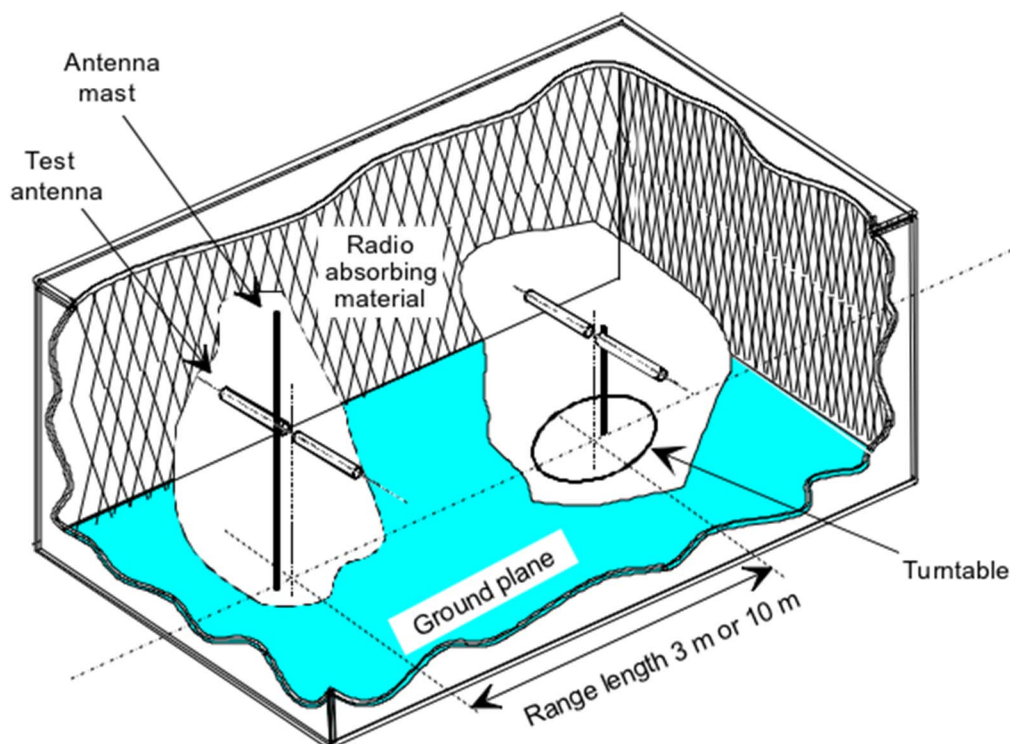

Figure B.2: A typical Anechoic Chamber with a conductive ground plane

In this facility the ground plane creates the wanted reflection path, such that the signal received by the receiving antenna is the sum of the signals from both the direct and reflected transmission paths. This creates a unique received signal level for each height of the transmitting antenna (or EUT) and the receiving antenna above the ground plane.

The antenna mast provides a variable height facility (from 1 m to 4 m) so that the position of the test antenna can be optimized for maximum coupled signal between antennas or between an EUT and the test antenna.

A turntable is capable of rotation through 360° in the horizontal plane and it is used to support the test sample (EUT) at a specified height, usually 1,5 m above the ground plane. The chamber shall be large enough to allow the measuring distance of at least 3 m or $2(d_1 + d_2)^2 / \lambda$ (m), whichever is greater (see clause B.2.5). The distance used in actual measurements shall be recorded with the test results.

Emission testing involves firstly "peaking" the field strength from the EUT by raising and lowering the receiving antenna on the mast (to obtain the maximum constructive interference of the direct and reflected signals from the EUT) and then rotating the turntable for a "peak" in the azimuth plane. At this height of the test antenna on the mast, the amplitude of the received signal is noted. Secondly the EUT is replaced by a substitution antenna (positioned at the EUT's phase or volume centre), which is connected to a signal generator. The signal is again "peaked" and the signal generator output adjusted until the level, noted in stage one, is again measured on the receiving device.

Receiver sensitivity tests over a ground plane also involve "peaking" the field strength by raising and lowering the test antenna on the mast to obtain the maximum constructive interference of the direct and reflected signals, this time using a measuring antenna which has been positioned where the phase or volume centre of the EUT will be during testing. A transform factor is derived. The test antenna remains at the same height for stage two, during which the measuring antenna is replaced by the EUT. The amplitude of the transmitted signal is reduced to determine the field strength level at which a specified response is obtained from the EUT.

B.1.4 Open Area Test Site (OATS)

An Open Area Test Site comprises a turntable at one end and an antenna mast of variable height at the other end above a ground plane, which in the ideal case, is perfectly conducting and of infinite extent. In practice, whilst good conductivity can be achieved, the ground plane size has to be limited. A typical Open Area Test Site is shown in figure B.3.

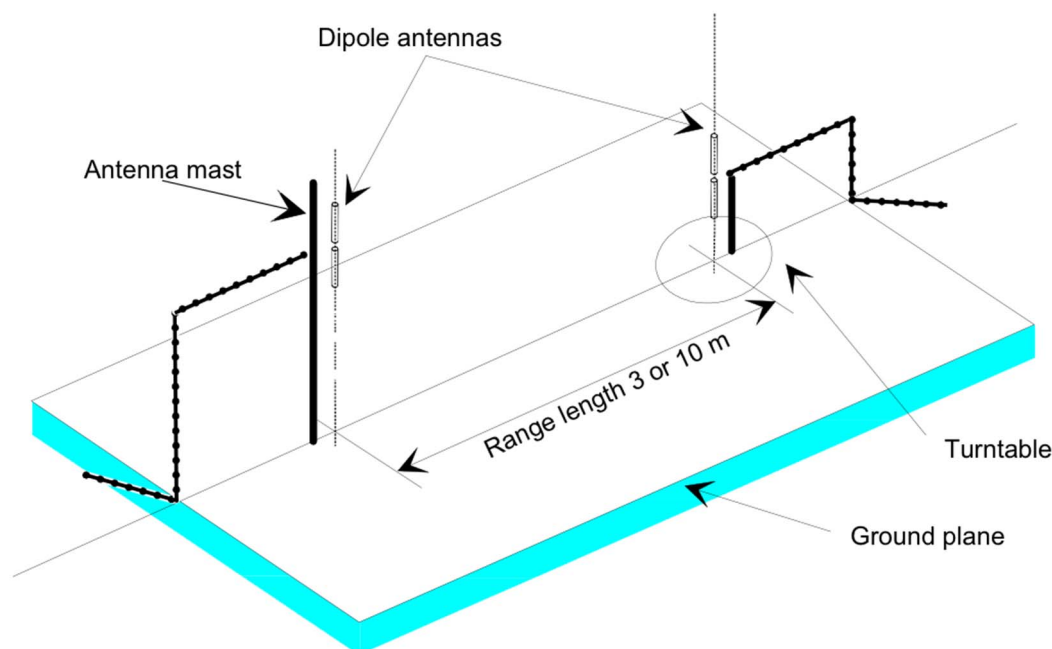

Figure B.3: A typical Open Area Test Site

The ground plane creates a wanted reflection path, such that the signal received by the receiving antenna is the sum of the signals received from the direct and reflected transmission paths. The phasing of these two signals creates a unique received level for each height of the transmitting antenna (or EUT) and the receiving antenna above the ground plane.

Site qualification concerning antenna positions, turntable, measurement distance and other arrangements are same as for anechoic chamber with a ground plane. In radiated measurements an OATS is also used by the same way as anechoic chamber with a ground plane.

Typical measuring arrangement common for ground plane test sites is presented in figure B.4.

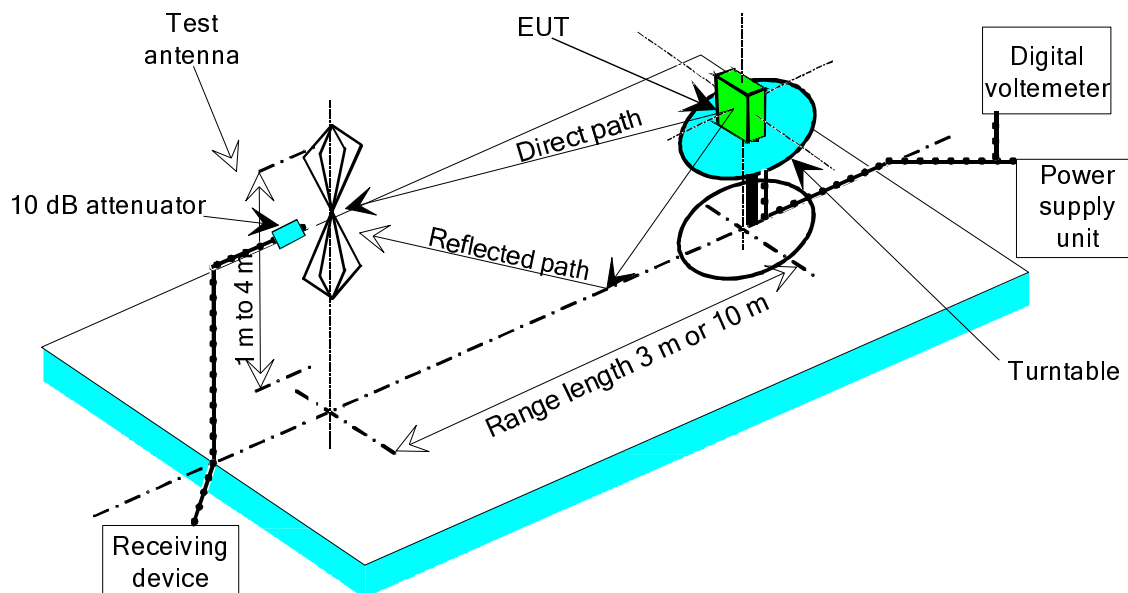

Figure B.4: Measuring arrangement on ground plane test site (OATS set-up for spurious emission testing)

B.1.5 Test antenna

A test antenna is always used in radiated test methods. In emission tests (i.e. frequency error, effective radiated power, spurious emissions and adjacent channel power) the test antenna is used to detect the field from the EUT in one stage of the measurement and from the substitution antenna in the other stage. When the test site is used for the measurement of receiver characteristics (i.e. sensitivity and various immunity parameters) the antenna is used as the transmitting device.

The test antenna should be mounted on a support capable of allowing the antenna to be used in either horizontal or vertical polarization which, on ground plane sites (i.e. anechoic chambers with ground planes and Open Area Test Sites), should additionally allow the height of its centre above the ground to be varied over the specified range (usually 1 m to 4 m).

In the frequency band 30 MHz to 1 000 MHz, dipole antennas which shall be constructed in accordance with IEEE/ANSI C63.5 [2] are generally recommended. For frequencies of 80 MHz and above, the dipoles should have their arm lengths set for resonance at the frequency of test. Below 80 MHz, shortened arm lengths are recommended. For spurious emission testing, however, a combination of bicones and log periodic dipole array antennas (commonly termed "log periodics") could be used to cover the entire 30 MHz to 1 000 MHz band. Above 1 000 MHz, waveguide horns are recommended although, again, log periodics could be used.

NOTE: The gain of a horn antenna is generally expressed relative to an isotropic radiator.

B.1.6 Substitution antenna

The substitution antenna is used to replace the EUT for tests in which a transmitting parameter (i.e. frequency error, effective radiated power, spurious emissions and adjacent channel power) is being measured. For measurements in the frequency band 30 MHz to 1 000 MHz, the substitution antenna should be a dipole antenna (constructed in accordance with IEEE/ANSI C63.5 [2]). For frequencies of 80 MHz and above, the dipoles should have their arm lengths set for resonance at the frequency of test. Below 80 MHz, shortened arm lengths are recommended. For measurements above 1 000 MHz, a waveguide horn is recommended. The centre of this antenna should coincide with either the phase centre or volume centre.

B.1.7 Measuring antenna

The measuring antenna is used in tests on an EUT in which a receiving parameter (i.e. sensitivity and various immunity tests) is being measured. Its purpose is to enable a measurement of the electric field strength in the vicinity of the EUT.

For measurements in the frequency band 30 MHz to 1 000 MHz, the measuring antenna should be a dipole antenna (constructed in accordance with IEEE/ANSI C63.5 [2]). For frequencies of 80 MHz and above, the dipoles should have their arm lengths set for resonance at the frequency of test. Below 80 MHz, shortened arm lengths are recommended. The centre of this antenna should coincide with either the phase centre or volume centre (as specified in the test method) of the EUT.

B.1.8 Stripline arrangement

B.1.8.1 General

The stripline arrangement is a RF coupling device for coupling the integral antenna of an equipment to a 50 Ω radio frequency terminal. This allows the radiated measurements to be performed without an open air test site but in a restricted frequency range. Absolute or relative measurements can be performed; absolute measurements require a calibration of the stripline arrangement.

B.1.8.2 Description

The stripline is made of three highly conductive sheets forming part of a transmission line, which allows the equipment under test to be placed within a known electric field. They shall be sufficiently rigid to support the equipment under test.

One example of stripline characteristics are given in table B.1.

Table B.1

		IEC 60489-3 App. J [i.4]
Useful frequency range	MHz	1 to 200
Equipment size limits (antenna included)	Length	200 mm
	Width	200 mm
	Height	250 mm

B.1.8.3 Calibration

The aim of calibration is to establish at any frequency a relationship between the voltage applied by the signal generator and the field strength at the designated test area inside the stripline.

B.1.8.4 Mode of use

The stripline arrangement may be used for all radiated measurements within its calibrated frequency range.

The method of measurement is the same as the method using an open air test site with the following change. The stripline arrangement input socket is used instead of the test antenna.

B.2 Guidance on the use of radiation test sites

B.2.1 General

This clause details procedures, test equipment arrangements and verification that should be carried out before any of the radiated tests are undertaken. These schemes are common to all types of test sites described in annex B.

B.2.2 Verification of the test site

No test shall be carried out on a test site which does not possess a valid certificate of verification. The verification procedures for the different types of test sites described in annex B (i.e. anechoic chamber, anechoic chamber with a ground plane and Open Area Test Site) are given in ETSI TR 102 273 [i.13].

B.2.3 Preparation of the EUT

The manufacturer should supply information about the EUT covering the operating frequency, polarization, supply voltage(s) and the reference face. Additional information, specific to the type of EUT should include, where relevant, carrier power, channel separation, whether different operating modes are available (e.g. high and low power modes) and if operation is continuous or is subject to a maximum test duty cycle (e.g. 1 minute on, 4 minutes off).

Where necessary, a mounting bracket of minimal size should be available for mounting the EUT on the turntable. This bracket should be made from low conductivity, low relative dielectric constant (i.e. less than 1,5) material(s) such as expanded polystyrene, balsa wood, etc.

B.2.4 Power supplies to the EUT

All tests should be performed using power supplies wherever possible, including tests on EUT designed for battery-only use. In all cases, power leads should be connected to the EUT's supply terminals (and monitored with a digital voltmeter) but the battery should remain present, electrically isolated from the rest of the equipment, possibly by putting tape over its contacts.

The presence of these power cables can, however, affect the measured performance of the EUT. For this reason, they should be made to be "transparent" as far as the testing is concerned. This can be achieved by routing them away from the EUT and down to the either the screen, ground plane or facility wall (as appropriate) by the shortest possible paths. Precautions should be taken to minimize pick-up on these leads (e.g. the leads could be twisted together, loaded with ferrite beads at 0,15 metres spacing or otherwise loaded).

B.2.5 Range length

The range length for all these types of test facility for testing in the far-field of the EUT i.e. it should be equal to or exceed:

$$\frac{2(d_1 + d_2)^2}{\lambda}$$

where:

d_1 is the largest dimension of the EUT/dipole after substitution (m);

d_2 is the largest dimension of the test antenna (m);

λ is the test frequency wavelength (m).

It should be noted that in the substitution part of this measurement, where both test and substitution antennas are half wavelength dipoles, this minimum range length for far-field testing would be: 2λ .

It should be noted in the test report when either of these conditions is not met so that the additional measurement uncertainty can be incorporated into the results.

NOTE 1: For the fully anechoic chamber, no part of the volume of the EUT should, at any angle of rotation of the turntable, fall outside the "quiet zone" of the chamber at the nominal frequency of the test.

NOTE 2: The "quiet zone" is a volume within the anechoic chamber (without a ground plane) in which a specified performance has either been proven by test, or is guaranteed by the designer/manufacture. The specified performance is usually the reflectivity of the absorbing panels or a directly related parameter (e.g. signal uniformity in amplitude and phase). It should be noted however that the defining levels of the quiet zone tend to vary.

NOTE 3: **For the anechoic chamber with a ground plane**, a full height scanning capability, i.e. 1 m to 4 m, should be available for which no part of the test antenna should come within 1 m of the absorbing panels. For both types of Anechoic Chamber, the reflectivity of the absorbing panels should not be worse than -5 dB.

NOTE 4: **For both the anechoic chamber with a ground plane and the Open Area Test Site**, no part of any antenna should come within 0,25 m of the ground plane at any time throughout the tests. Where any of these conditions cannot be met, measurements should not be carried out.

B.2.6 Site preparation

The cables for both ends of the test site should be routed horizontally away from the testing area for a minimum of 2 m (unless, in the case both types of anechoic chamber, a back wall is reached) and then allowed to drop vertically and out through either the ground plane or screen (as appropriate) to the test equipment. Precautions should be taken to minimize pick up on these leads (e.g. dressing with ferrite beads, or other loading). The cables, their routing and dressing should be identical to the verification set-up.

NOTE: For ground reflection test sites (i.e. anechoic chambers with ground planes and Open Area Test Sites), which incorporate a cable drum with the antenna mast, the 2 m requirement may be impossible to comply with.

Calibration data for all items of test equipment should be available and valid. For test, substitution and measuring antennas, the data should include gain relative to an isotropic radiator (or antenna factor) for the frequency of test. Also, the VSWR of the substitution and measuring antennas should be known.

The calibration data on all cables and attenuators should include insertion loss and VSWR throughout the entire frequency range of the tests. All VSWR and insertion loss figures should be recorded in the log book results sheet for the specific test.

Where correction factors/tables are required, these should be immediately available.

For all items of test equipment, the maximum errors they exhibit should be known along with the distribution of the error e.g.:

- cable loss: $\pm 0,5$ dB with a rectangular distribution;
- measuring receiver: 1,0 dB (standard deviation) signal level accuracy with a Gaussian error distribution.

At the start of measurements, system checks should be made on the items of test equipment used on the test site.

B.3 Coupling of signals

B.3.1 General

The presence of leads in the radiated field may cause a disturbance of that field and lead to additional measurement uncertainty. These disturbances can be minimized by using suitable coupling methods, offering signal isolation and minimum field disturbance (e.g. optical and acoustic coupling).

B.3.2 Data signals

Isolation can be provided by the use of optical, ultrasonic or infrared means. Field disturbance can be minimized by using a suitable fibre optic connection. Ultra sonic or infrared radiated connections require suitable measures for the minimization of ambient noise.

B.4 Standard test position

The standard position in all test sites, except the stripline arrangement, for equipment which is not intended to be worn on a person, including hand-held equipment, shall be on a non conducting support, height 1,5 m, capable of rotating about a vertical axis through the equipment. The standard position of the equipment shall be the following:

- a) for equipment with an internal antenna, it shall be placed in the position closest to normal use as declared by the manufacturer;
- b) for equipment with a rigid external antenna, the antenna shall be vertical;
- c) for equipment with a non-rigid external antenna, the antenna shall be extended vertically upwards by a non-conducting support.

Equipment which is intended to be worn on a person may be tested using a simulated man as support. The simulated man comprises a rotatable acrylic tube filled with salt water, placed on the ground.

The container shall have the following dimensions:

- Height: 1,7 m \pm 0,1 m;
Inside diameter: 300 mm \pm 5 mm;
Sidewall thickness: 5 mm \pm 0,5 mm.

The container shall be filled with a salt (NaCl) solution of 1,5 g per litre of distilled water.

The equipment shall be fixed to the surface of the simulated man, at the appropriate height for the equipment.

NOTE: To reduce the weight of the simulated man it may be possible to use an alternative tube which has a hollow centre of 220 mm maximum diameter.

In the stripline arrangement the equipment under test or the substitution antenna is placed in the designated test area in the normal operational position, relative to the applied field, on a pedestal made of a low dielectric material (dielectric constant less than 2).

B.5 Test fixture

B.5.1 General

The test fixture is only needed for the assessment of integral antenna equipment.

B.5.2 Description

The test fixture is a radio frequency coupling device associated with an integral antenna equipment for coupling the integral antenna to a 50 Ω radio frequency terminal at the working frequencies of the equipment under test. This allows certain measurements to be performed using the conducted measurement methods. Only relative measurements may be performed and only those at or near frequencies for which the test fixture has been calibrated.

In addition, the test fixture may provide:

- a connection to an external power supply;
- in the case of assessment of speech equipment, an audio interface either by direct connection or by an acoustic coupler.

In the case of non-speech equipment, the test fixture can also provide the suitable coupling means e.g. for the data output.

The test fixture shall normally be provided by the manufacturer.

The performance characteristics of the test fixture shall be approved by the testing laboratory and shall conform to the following basic parameters:

- a) the coupling loss shall not be greater than 30 dB;
- b) a coupling loss variation over the frequency range used in the measurement which does not exceed 2 dB;
- c) circuitry associated with the RF coupling shall contain no active or non-linear devices;
- d) the VSWR at the 50 Ω socket shall not be more than 1,5 over the frequency range of the measurements;
- e) the coupling loss shall be independent of the position of the test fixture and be unaffected by the proximity of surrounding objects or people. The coupling loss shall be reproducible when the equipment under test is removed and replaced;
- f) the coupling loss shall remain substantially constant when the environmental conditions are varied.

The characteristics and calibration shall be included in the test report.

B.5.3 Calibration

The calibration of the test fixture establishes a relationship between the output of the signal generator and the field strength applied to the equipment placed in the test fixture.

The calibration is valid only at a given frequency and for a given polarization of the reference field.

The actual set-up used depends on the type of the equipment (e.g. data, speech, etc.).

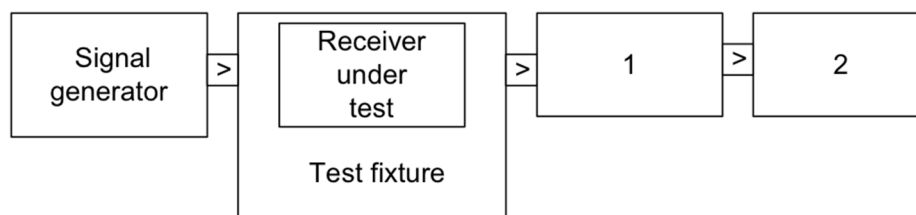

- 1) Coupling device.
- 2) Device for assessing the performance, e.g. distortion factor, BER measuring device, etc.

Figure B.5: Measuring arrangement for calibration

Method of calibration:

- Measure the sensitivity expressed as a field strength, as specified in the present document and note the value of this field strength in dB μ V/m and the polarization used.
- Place the receiver in the test fixture, which is connected to the signal generator. The level of the signal generator producing:
 - a bit error ratio of 0,01; or
 - a message acceptance ratio of 80 %, as appropriate;
 shall be noted.

The calibration of the test fixture is the relationship between the field strength in dB μ V/m and the signal generator level in dB μ V emf. This relationship is expected to be linear.

B.5.4 Mode of use

The test fixture may be used to facilitate some of the measurements in the case of equipment having an integral antenna.

It is used in particular for the measurement of the radiated carrier power and usable sensitivity expressed as a field strength under extreme test conditions.

For the transmitter measurements calibration is not required as relative measuring methods are used.

For the receiver measurements calibration is necessary in order to determine absolute measurement levels.

To apply the specified wanted signal level expressed in field strength, convert it into the signal generator level (emf) using the calibration of the test fixture. Apply this value to the signal generator.

Annex C (normative):
Void

Annex D (informative): Measurement uncertainty

The interpretation of the results recorded in the test report for the measurements described in the present document in respect to measurement uncertainty should be as follows:

- the value of the measurement uncertainty for the measurement of each parameter should be separately included in the test report;
- the value of the measurement uncertainty should be, for each measurement, equal to or less than the figures in table D.1.

Table D.1: Maximum measurement uncertainty

Parameter	Uncertainty
Radio frequency	$\pm 1 \times 10^{-7}$
RF power, conducted	$\pm 1,5$ dB
Conducted spurious emission of transmitter, valid up to 6 GHz	± 3 dB
Conducted emission of receivers	± 3 dB
Radiated emission of transmitter, valid up to 6 GHz	± 6 dB
Radiated emission of receiver, valid up to 6 GHz	± 6 dB
RF level uncertainty for a given BER	$\pm 1,5$ dB
Two-signal measurements	± 4 dB
Time	± 5 %
Temperature	± 1 °C
Humidity	± 10 %

For the test methods, according to the present document, the measurement uncertainty figures should be calculated and should correspond to an expansion factor (coverage factor) $k = 1,96$ or $k = 2$ (which provide confidence levels of respectively 95 % and 95,45 % in the case where the distributions characterizing the actual measurement uncertainties are normal (Gaussian)).

Annex E (informative): Receiver parameter assessment

This annex covers the assessment on receiver parameter under article 3.2 testing referring to ETSI EG 203 336 [i.19] addressing all sub-clauses in ETSI EG 203 336, clause 5.3, which are listed in table E.1.

Table E.1: Reader receiver parameter assessment

ETSI EG 203 336 clause	ETSI EG 203 336, clause title	Tested	Justification or reference
5.3.2	Receiver sensitivity	YES	See clause 4.4.5.
5.3.3	Receiver co-channel rejection	NO	Interrogator receivers utilizes AM and require a C/I between 10 dB and 14 dB with no inherent protection to interference. The test would just confirm that well know property of AM receivers with no additional information.
5.3.4.2.1	Receiver adjacent signal selectivity (adjacent channel selectivity)	YES	See clause 4.4.4.
5.3.4.2.2	Receiver spurious response rejection	YES	See clause 4.4.1.
5.3.4.3.1	Receiver blocking	YES	See clause 4.4.2.
5.3.4.3.2	Receiver radio-frequency intermodulation	YES	See clause 4.4.6.
5.3.4.3.3	Receiver adjacent signal selectivity (adjacent channel selectivity)	YES	See clause 4.4.1.
5.3.4.4.1	Receiver dynamic range	YES, INDIRECT	The receiver dynamic range is specified by clauses 4.4.5 (receiver sensitivity) and 4.4.2 (receiver blocking).
5.3.4.4.2	Reciprocal mixing	NO	Not required, as a tag backscatters the interrogators transmit signal and is therefore an interrogator receiver rejects phase noise up to the correlation bandwidth of the tag-interrogator system typical greater than 1 MHz. This is outside the receive band, which is always less than 1 MHz (e.g. 320 kHz / 640 kHz).
5.3.4.4.3	Desensitization	YES, INDIRECT	The desensitization is specified by clause 4.4.2 (Receiver blocking).
5.3.5	Receiver unwanted emissions in the spurious domain	YES	See clause 4.5.2.

Annex F (informative): Bibliography

- IEC Publication 489-3 Second edition (1988), Appendix F pages 130 to 133.
- Ketterling, H-P: "Verification of the performance of fully and semi-anechoic chambers for radiation measurements and susceptibility/immunity testing", 1991, Leatherhead/Surrey.
- Directive 2004/108/EC of the European Parliament and of the Council of 15 December on the approximation of the laws of the Member States relating to electromagnetic compatibility and replacing Directive 89/336/EC.
- CEPT/ERC Recommendation 01-06: "Procedure for mutual recognition of type testing and type approval for radio equipment".
- Recommendation ITU-R BS.559-2: "Objective measurement of radio-frequency protection ratios in LF, MF and HF broadcasting".
- ETSI TR 100 027: "ElectroMagnetic Compatibility and Radio Spectrum Matters (ERM); Methods of measurement for private mobile radio equipment".
- ETSI EN 300 220 (all parts): "Electromagnetic compatibility and Radio spectrum Matters (ERM); Short Range Devices (SRD); Radio equipment to be used in the 25 MHz to 1 000 MHz frequency range with power levels ranging up to 500 mW".
- Directive 98/34/EC of the European Parliament and of the Council of 22 June 1998 laying down a procedure for the provision of information in the field of technical standards and regulations.
- ETSI EN 301 489-1: "Electromagnetic compatibility and Radio spectrum Matters (ERM); ElectroMagnetic Compatibility (EMC) standard for radio equipment and services; Part 1: Common technical requirements".
- ETSI EN 301 489-3: "ElectroMagnetic Compatibility (EMC) standard for radio equipment and services; Part 3: Specific conditions for Short-Range Devices (SRD) operating on frequencies between 9 kHz and 246 GHz; Harmonised Standard covering the essential requirements of article 3.1(b) of Directive 2014/53/EU".

Annex G (informative): Change history

Version	Information about changes
3.1.2	Update to address comments from the European Commission received on measurement uncertainty.
3.2.1	Following the European Commission implementing Decision (EU) 2018/1538 of 11 October 2018 the related update of CEPT 70 03 the mitigation method has been removed. Furthermore, the 3 or 4 channels for 915-921 MHz have been described as well.
3.2.1	Following ERC Recommendation 74-01 [i.16], table 2 and figure 8 have been updated. Following the reader receiver parameter assessment in annex E reader receiver tests have been introduced as listed in annex E.

History

Document history		
V1.1.1	September 2004	Publication as ETSI EN 302 208 part 1 and part 2
V1.1.2	July 2006	Publication as ETSI EN 302 208 part 1
V1.2.1	April 2008	Publication as ETSI EN 302 208 part 1 and part 2
V1.3.1	February 2010	Publication as ETSI EN 302 208 part 1 and part 2
V1.4.1	November 2011	Publication as ETSI EN 302 208 part 1 and part 2
V2.1.1	February 2015	Publication as ETSI EN 302 208 part 1 and part 2
V3.1.1	November 2016	Publication
V3.2.0	February 2018	EN Approval Procedure AP 20180517: 2018-02-16 to 2018-05-17
V3.3.0	May 2020	EN Approval Procedure AP 20200804: 2020-05-06 to 2020-08-04
V3.3.1	August 2020	Publication